

AIR TO WATER

Super high power series

DESIGN & TECHNICAL MANUAL

Split type

HYDRAULIC
INDOOR



WSYG160DJ6



WSYK170DJ9

OUTDOOR



WOYG160LJL



WOYK150LJL
WOYK170LJL

Notices:

- Product specifications and design are subject to change without notice for future improvement.
- For further details, please check with our authorized dealer.

CONTENTS

1. OUTDOOR UNIT

2. HYDRAULIC INDOOR UNITS

3. CONTROL SYSTEM



1. OUTDOOR UNIT

CONTENTS

1. OUTDOOR UNIT

1. Specifications	01-1
1-1. Nominal capacity and nominal input	01-1
1-2. Technical specifications	01-2
1-3. Product fiche	01-2
1-4. Product information	01-3
1-5. Electrical specifications	01-4
2. Dimensions	01-5
2-1. Models: WOYG160LJL, WOYK150LJL, and WOYK170LJL	01-5
3. Installation space	01-7
3-1. Space requirement	01-7
4. Piping diagrams	01-10
4-1. Models: WOYG160LJL, WOYK150LJL, and WOYK170LJL	01-10
5. Wiring diagrams	01-11
5-1. Model: WOYG160LJL	01-11
5-2. Models: WOYK150LJL and WOYK170LJL	01-12
6. External input and output	01-13
6-1. External input	01-13
6-2. External output	01-15
7. Function settings	01-17
7-1. Local setting switch buttons	01-17
7-2. Local setting procedure	01-19
8. Heating capacity table	01-21
8-1. Model: WOYG160LJL	01-21
8-2. Model: WOYK150LJL	01-22
8-3. Model: WOYK170LJL	01-22
9. Cooling capacity table	01-23
9-1. Model: WOYG160LJL	01-23
9-2. Model: WOYK150LJL	01-23
9-3. Model: WOYK170LJL	01-23
10. Operation noise (sound pressure)	01-24
10-1. Noise level curve	01-24
10-2. Sound level check point	01-25
11. Operation range	01-26
11-1. Models: WOYG160LJL, WOYK150LJL, and WOYK170LJL	01-26
12. Safety devices	01-27
13. Accessories	01-28

1. Specifications

1-1. Nominal capacity and nominal input

Outdoor unit model name				WOYG160LJL	WOYK150LJL	WOYK170LJL	
Power supply				1 Ø 230 V ~ 50 Hz	3 Ø 400 V ~ 50 Hz		
-22°C/+55°C Floor heating	Heating capacity	Nominal	kW	8.57	8.57	8.96	
	Input power	Nominal	kW	6.30	6.26	6.59	
	COP	Nominal		1.36	1.37	1.36	
-15°C/+55°C Floor heating	Heating capacity	Nominal	kW	9.50	9.50	10.60	
	Input power	Nominal	kW	5.76	5.65	6.31	
	COP	Nominal		1.65	1.68	1.68	
-15°C/+60°C Floor heating	Heating capacity	Nominal	kW	9.00	9.20	9.85	
	Input power	Nominal	kW	6.04	5.82	6.27	
	COP	Nominal		1.49	1.58	1.56	
-7°C/+35°C Floor heating	Heating capacity	Nominal	kW	14.50	13.20	15.00	
	Input power	Nominal	kW	5.27	4.55	5.32	
	COP	Nominal		2.75	2.90	2.82	
-7°C/+55°C Floor heating	Heating capacity	Nominal	kW	10.90	13.20	14.20	
	Input power	Nominal	kW	5.89	6.77	7.40	
	COP	Nominal		1.85	1.95	1.92	
-7°C/+60°C Floor heating	Heating capacity	Nominal	kW	10.80	11.20	11.70	
	Input power	Nominal	kW	6.03	6.18	6.50	
	COP	Nominal		1.79	1.81	1.80	
+2°C/+35°C Floor heating	COP priority	Heating capacity	Nominal	kW	9.60	9.60	10.20
		Input power	Nominal	kW	2.58	2.57	2.75
		COP	Nominal		3.72	3.74	3.71
	Capacity priority	Heating capacity	Nominal	kW	13.30	13.20	13.50
		Input power	Nominal	kW	4.25	4.06	4.27
		COP	Nominal		3.13	3.25	3.16
+7°C/+35°C Floor heating	Heating capacity	Minimum			6.59	6.63	6.78
		Nominal		kW	16.00	15.00	17.00
		Maximum			22.93	22.70	24.27
	Input power	Nominal	kW	3.86	3.46	4.10	
	COP	Nominal		4.15	4.33	4.15	
	+7°C/+55°C Floor heating	Heating capacity	Nominal	kW	14.50	13.20	15.00
Input power		Nominal	kW	5.58	4.77	5.49	
COP		Nominal		2.60	2.77	2.73	

NOTE: Test conditions are complied with EN14511-2

1-2. Technical specifications

Outdoor unit model name				WOYG160LJL	WOYK150LJL	WOYK170LJL	
Enclosure	Material			Painted galvanized steel			
	Color			Beige Approximate color of Munsell 10YR 7.5/1.0NN			
Dimensions (H × W × D)	Net			1,428 × 1,080 × 480			
	Gross			1,557 × 1,174 × 600			
Weight	Net			137			
	Gross			157			
Heat exchanger	Dimensions (H × W × D)		mm	1,386 × 1,293 × 36.38			
	Fin pitch			1.45			
	Rows × Stages			2.6 × 66			
	Pipe type			Copper			
	Fin type	Type (Material)	Corrugate (Aluminum)				
		Surface treatment	Corrosion resistance (Blue fin)				
Fan	Airflow rate	Heating	m ³ /h	6,250			
	Type × Q'ty			Propeller fan × 2			
	Discharge direction		Horizontal				
	Motor quantity		2				
	Motor output		W	100			
Compressor	Type		DC 2 rotary (liquid injection) × 1				
	Motor output		W	3,750			
Operation range	Heating	Minimum	°CDB	-25			
		Maximum	°CWB	35			
	Sanitary water	Minimum	°CDB	-25			
		Maximum	°CWB	35			
Refrigerant	Type (Global Warming Potential)		R410A (2,088)				
	Charge		g	3,800			
	Control		Expansion valve (electric type)				
	Number of circuits		1				
Refrigerant oil	Type		VG74				
	Charged volume		l	1.55			
Connection pipe	Connection method	Liquid	mm	Flare connection			
		Gas		Flare connection			
	Size (standard)	Liquid	mm	Ø9.52			
		Gas		Ø15.88			
	Drain	Type × Q'ty	Socket × 3				
		Size	mm	Ø20			
	Pre-charge length		m	15			
	Max. length			30			
	Min. length			5			
	Additional refrigerant charge		g/m	50			
Max. height difference		m	25/15 (Outdoor unit: Higher/Lower)				
Defrost method				Reverse cycle			
Defrost control				Outdoor unit heat exchanger temperature sensor			
Capacity control method				Inverter control			

1-3. Product fiche

Model name	Hydraulic indoor unit		WSYG160DJ6		WSYK170DJ9			
	Outdoor unit		WOYG160LJL		WOYK150LJL		WOYK170LJL	
Temperature application	°C		55	35	55	35	55	35
Declared load profile			—	—	—	—	—	—
Seasonal space heating energy efficiency class			A++	A++	A++	A++	A++	A++
Water heating energy efficiency class			—	—	—	—	—	—
Rated heat output	kW		14	16	16	17	17	18
Supplementary heater	kW		6	6	9	9	9	9
Annual energy consumption	kWh		8,757	8,014	9,915	8,606	10,232	9,059
Annual electricity consumption	kWh		—	—	—	—	—	—
Annual fuel consumption	GJ		Not applicable					
Seasonal space heating energy efficiency	%		125	163	130	164	130	161
Water heating energy efficiency	%		—	—	—	—	—	—
Sound power level	Indoor unit	dB	45	45	45	45	45	45
Work only during off-peak hours			Not applicable					
Specific precautions in assembled, installed, or maintained			Refer to the installation and operating manuals.					
Rated heat output	Colder climate	kW	14	16	16	17	17	18
	Warmer climate	kW	10	14	11	15	12	16
Annual energy consumption	Colder climate	kWh	11,478	11,095	12,973	11,470	13,525	12,202
	Warmer climate	kWh	3,557	3,953	4,421	4,520	4,613	4,872
Annual electricity consumption	Colder climate	kWh	—	—	—	—	—	—
	Warmer climate	kWh	—	—	—	—	—	—
Seasonal space heating energy efficiency	Colder climate	%	114	140	119	147	117	143
	Warmer climate	%	146	193	135	179	136	176
Water heating energy efficiency	Colder climate	%	—	—	—	—	—	—
	Warmer climate	%	—	—	—	—	—	—
Sound power level	Outdoor unit	dB	67	66	67	66	67	68

NOTES:

- Product fiche according to Commission Delegated Regulation (EU) 811/2013
- Acoustic noise information:
 - The maximum sound pressure level is less than 70 dB (A) for both hydraulic unit and outdoor unit.
 - According to IEC 704-1 and ISO 3744.
- If the air to water heat pump is operated under higher temperature conditions than those listed, the built-in protection circuit may operate to prevent internal circuit damage. Also, during cooling modes, if the unit is used under conditions of lower temperatures than those listed above, the heat exchanger may freeze, leading to water leakage and other damage.
- Do not use this unit for any purposes other than the Heating and Cooling.

1-4. Product information

Model name	Hydraulic indoor unit		WSYG160DJ6		WSYK170DJ9			
	Outdoor unit		WOYG160LJL		WOYK150LJL		WOYK170LJL	
Air-to-water heat pump			Yes					
Water-to-water heat pump			No					
Brine-to-water heat pump			No					
Low-temperature heat pump			No					
Equipped with a supplementary heater			Yes					
Heat pump combination heater			No*1					
Temperature application	°C		55	35	55	35	55	35
Rated heat output*2	P _{rated}	kW	14	16	16	17	17	18
Seasonal space heating energy efficiency	η _s	%	125	163	130	164	130	161
Declared capacity for heating for part load at indoor temperature 20 °C and outdoor temperature T _j								
T _j = -7°C	P _{dh}	kW	12.0	14.2	14.2	15.4	15.0	16.0
T _j = +2°C	P _{dh}	kW	7.3	8.7	8.6	9.4	9.0	9.7
T _j = +7°C	P _{dh}	kW	6.3	7.0	6.4	6.7	6.3	6.8
T _j = +12°C	P _{dh}	kW	7.6	8.1	7.6	8.0	7.7	8.0
T _j = bivalent temperature	P _{dh}	kW	12.0	14.2	14.2	15.4	15.0	16.0
T _j = operation limit temperature	P _{dh}	kW	10.6	14.1	13.3	14.7	12.4	14.8
T _j = -15°C (if TOL < -20°C)	P _{dh}	kW	—	—	—	—	—	—
Bivalent temperature	T _{biv}	°C	-7	-7	-7	-7	-7	-7
Cycling interval capacity for heating	P _{cyc}	kW	Not applicable					
Degradation co-efficient*3	C _{dh}		0.9	0.9	0.9	0.9	0.9	0.9
Declared coefficient of performance or primary energy ratio for part load at indoor temperature 20 °C and outdoor temperature T _j								
T _j = -7°C	COP _d		1.98	2.79	2.12	2.90	2.10	2.82
T _j = +2°C	COP _d		3.15	4.17	3.30	4.19	3.32	4.13
T _j = +7°C	COP _d		4.30	5.34	4.21	5.13	4.23	5.01
T _j = +12°C	COP _d		5.99	6.76	6.02	6.83	5.95	6.64
T _j = bivalent temperature	COP _d		1.98	2.79	2.12	2.90	2.10	2.82
T _j = operation limit temperature	COP _d		1.75	2.54	1.88	2.62	1.76	2.61
T _j = -15°C (if TOL < -20°C)	COP _d		—	—	—	—	—	—
Operation limit temperature	TOL	°C	-10	-10	-10	-10	-10	-10
Cycling interval efficiency	COP _{cyc}		Not applicable					
Heating water operating limit temperature	WTOL	°C	60	60	60	60	60	60
Power consumption in modes other than active mode								
Off mode	P _{OFF}	kW	0.019	0.019	0.016	0.016	0.016	0.016
Thermostat-off mode	P _{TO}	kW	0.046	0.100	0.043	0.096	0.046	0.097
Standby mode	P _{SB}	kW	0.023	0.023	0.019	0.019	0.019	0.019
Crankcase heater mode	P _{CK}	kW	0.000	0.000	0.000	0.000	0.000	0.000
Supplementary heater								
Rated heat output*2	P _{SUP}	kW	3.0	2.0	2.7	2.7	4.1	3.1
Type of energy input	Electric							
Other items								
Capacity control			Variable					
Sound power level	Indoor unit	L _{WA}	dB	45	45	45	45	45
	Outdoor unit	L _{WA}	dB	67	66	67	66	67
Annual energy consumption	Q _{HE}	kWh	8,757	8,014	9,915	8,606	10,232	9,059
Emissions of nitrogen oxides	NO _x	mg/kWh	Not applicable					
Rated airflow rate	Outdoor unit	m ³ /h	6,250	6,250	6,250	6,250	6,250	6,250
Declared load profile								
Daily electricity consumption	Q _{elec}	kWh	—	—	—	—	—	—
Annual energy consumption	AEC	kWh	—	—	—	—	—	—
Water heating energy efficiency	η _{wh}	%	—	—	—	—	—	—
Daily fuel consumption	Q _{fuel}	kWh	Not applicable					
Contact details	FUJITSU GENERAL (EURO) GmbH Fritz-Vomfelde-Straße 26-32, 40547 Düsseldorf, Germany							
NOTES:								
<ul style="list-style-type: none"> Product information according to Commission Delegated Regulation (EU) 811/2013 Product information is based on the average climate condition. *1: When using an optional component, this function is available. *2: For heat pump space heaters and heat pump combination heaters, the rated heat output P_{rated} is equal to the design load for heating P_{design,th}, and the rated heat output of a supplementary heater P_{sup} is equal to the supplementary capacity for heating sup (T_j). *3: If C_{dh} is not determined by measurement then the default degradation coefficient is C_{dh} = 0.9. 								

Energy efficiency value

Application: 35°C								
Model name	Hydraulic indoor unit		WSYG160DJ6		WSYK170DJ9			
	Outdoor unit		WOYG160LJL		WOYK150LJL		WOYK170LJL	
Seasonal energy efficiency of heat pump for space heating			163		164		161	
Type of temperature control			(75) class		(75) class		(75) class	
Outdoor sensor (included in the package)			II	—	II	—	II	—
Modulating room thermostat (outdoor sensor included in the package)			—	VI	—	VI	—	VI
Bonus			2	4	2	4	2	4
Seasonal space heating energy efficiency of package in average climate conditions	%		165	167	166	168	163	165
Energy class of the packages			A++	A++	A++	A++	A++	A++
Seasonal space heating energy efficiency of package in warmer climate conditions	%		195	197	181	180	178	183
Seasonal space heating energy efficiency of package in colder climate conditions	%		142	144	149	151	145	147

Application: 55°C								
Model name	Hydraulic indoor unit		WSYG160DJ6		WSYK170DJ9			
	Outdoor unit		WOYG160LJL		WOYK150LJL		WOYK170LJL	
Seasonal energy efficiency of heat pump for space heating			125		130		130	
Type of temperature control			(75) class		(75) class		(75) class	
Outdoor sensor (included in the package)			II	—	II	—	II	—
Modulating room thermostat (outdoor sensor included in the package)			—	VI	—	VI	—	VI
Bonus			2	4	2	4	2	4
Seasonal space heating energy efficiency of package in average climate conditions	%		127	129	132	134	132	134
Energy class of the packages			A++	A++	A++	A++	A++	A++
Seasonal space heating energy efficiency of package in warmer climate conditions	%		148	150	137	139	138	140
Seasonal space heating energy efficiency of package in colder climate conditions	%		116	118	121	123	119	121

Class of temperature controller

Controller class			II		VI		
Contribution to energy efficiency	%		2		4		

NOTE: Controller class VI: UTW-C55XA, UTW-C58XD, UTW-C74TXF, UTW-C74HXF, UTW-C78XD

1-5. Electrical specifications

Outdoor unit model name			WOYG160LJL	WOYK150LJL	WOYK170LJL	
Available voltage range			198—264 V	342—456 V		
Power supply	Voltage	V	1 Ø 230			
	Frequency	Hz	50			
Maximum operating current*1			28.0	14.0		
Wiring spec.*2	Main fuse (circuit breaker) current		A	32		
	Power cable		mm ²	6.0 or more		
	Transmission cable	Size	mm ²	1.5 or more		
		Max. length	m	50		
Wiring connections quantity*3			For power supply	3		
			For connection with indoor	4		

NOTES:

- *1: Maximum operating current is the total current of the indoor unit and the outdoor unit.
- *2: Selected sample based on Japan Electrotechnical Standard and Codes Committee E0005.
- *3: Included earth wiring.

2. Dimensions

2-1. Models: WOYG160LJL, WOYK150LJL, and WOYK170LJL

Unit: mm

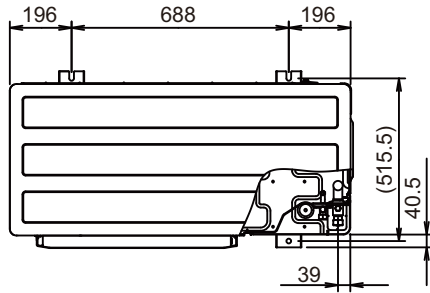

Top view

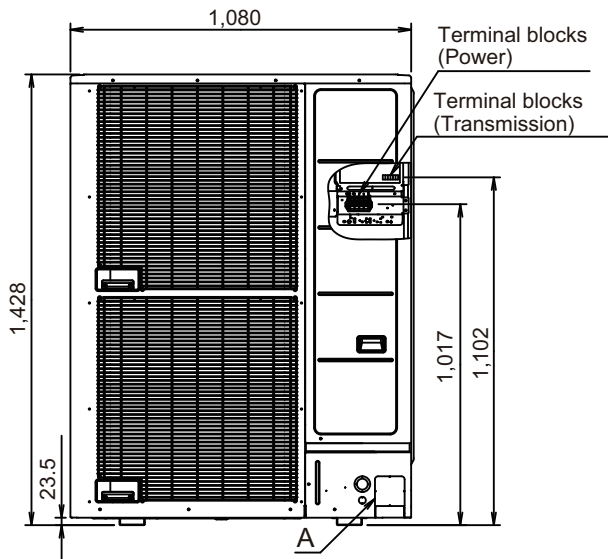

Front view

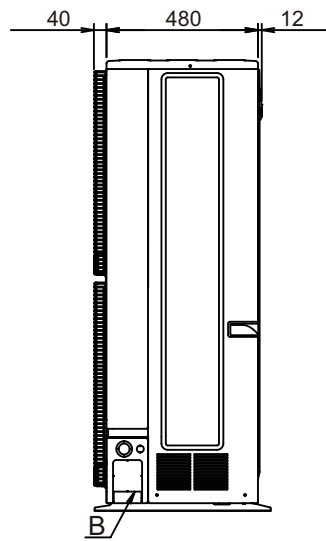

Side view

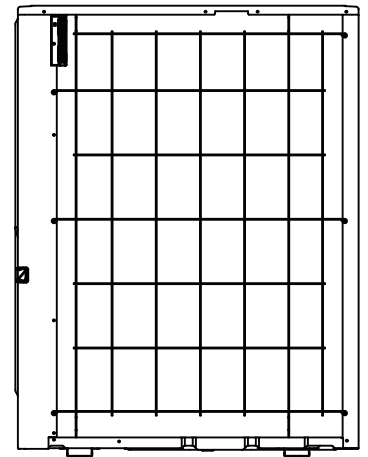

Rear view

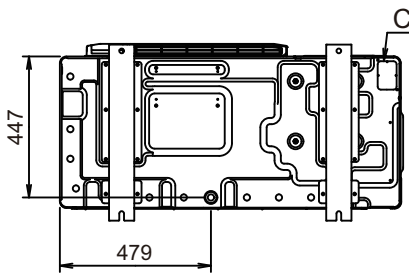

Bottom view

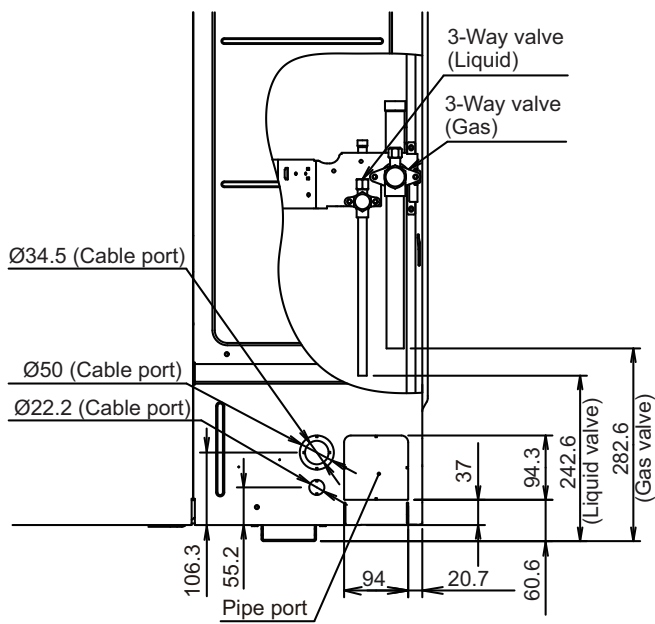

Detail A

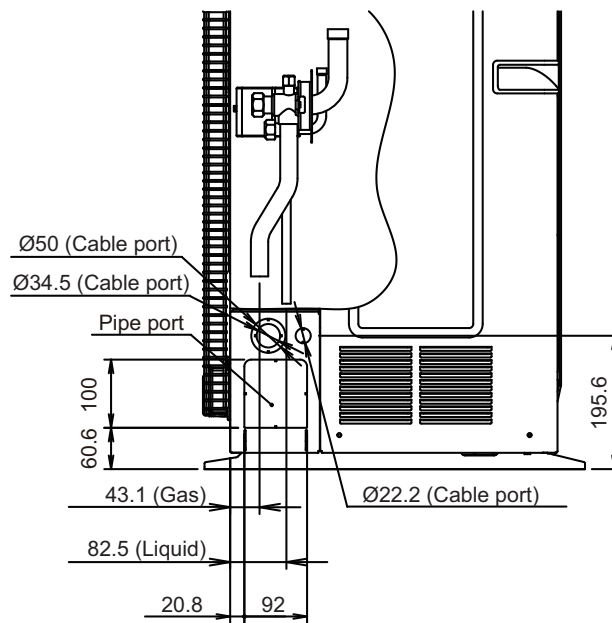

Detail B

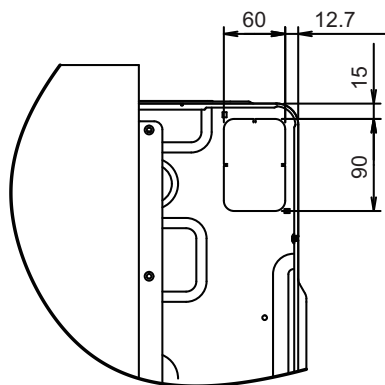

Detail C

3. Installation space

3-1. Space requirement

Provide sufficient installation space for product safety.

● Single outdoor unit installation

- When the upper space is open:

Unit: mm

When there are obstacles at the rear only.

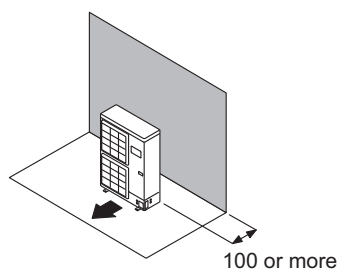

When there are obstacles at the rear and sides.

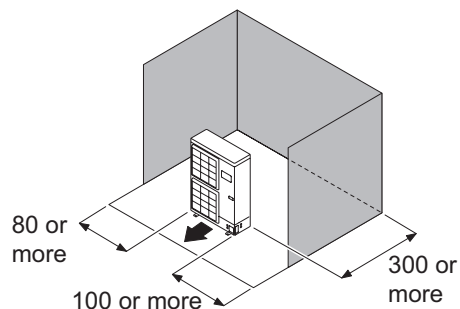

When there are obstacles at the front only.

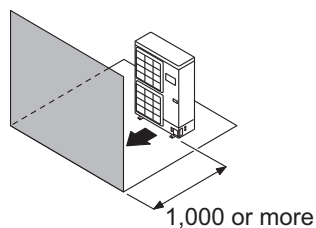

When there are obstacles at the front and rear.

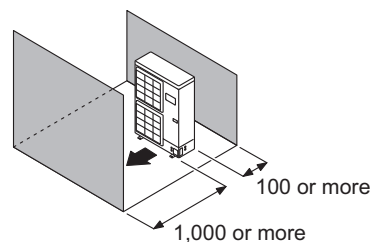

- When there is an obstruction in the upper space:

Unit: mm

When there are obstacles at the rear and above.

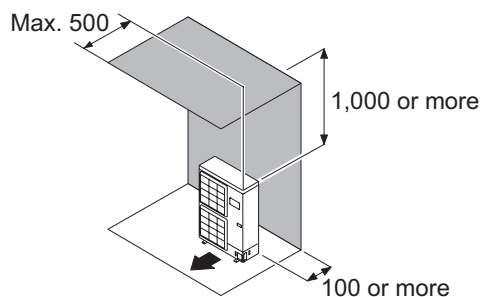

When there are obstacles at the rear, sides, and above.

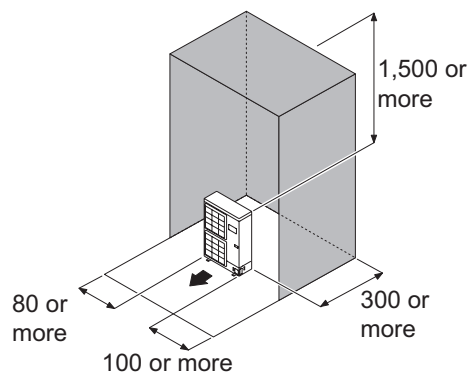

● Multiple outdoor unit installation

NOTES:

- Provide at least 100 mm of space between the outdoor units if multiple units are installed.
- When routing the piping from the side of an outdoor unit, provide space for the piping.
- No more than 3 units must be installed side by side.

When 3 units or more are arranged in a line, provide the space as shown in the following example when an obstruction is present also in the upward area.

- **When the upper space is open:**

Unit: mm

When there are obstacles at the rear only.

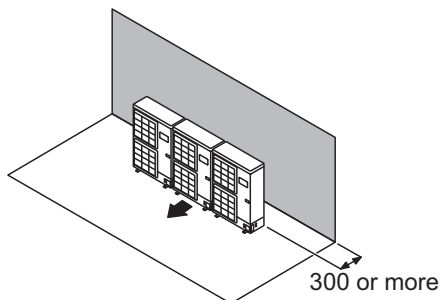

When there are obstacles at the front only.

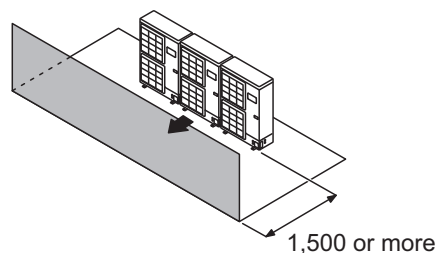

When there are obstacles at the front and rear.

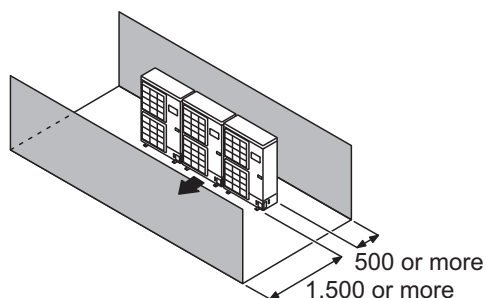

- **When there is an obstruction in the upper space:**

Unit: mm

When there are obstacles at the rear and above.

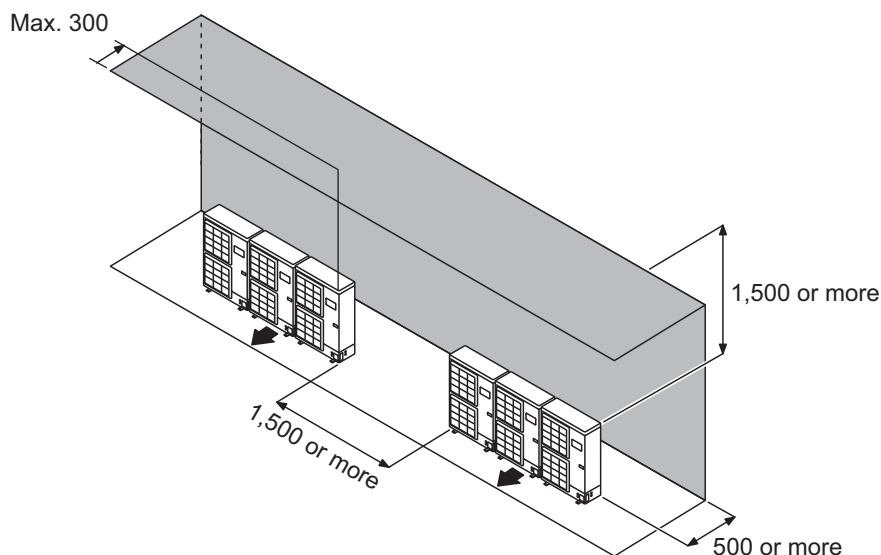

● Outdoor unit installation in multi-row

Unit: mm

Single parallel unit arrangement

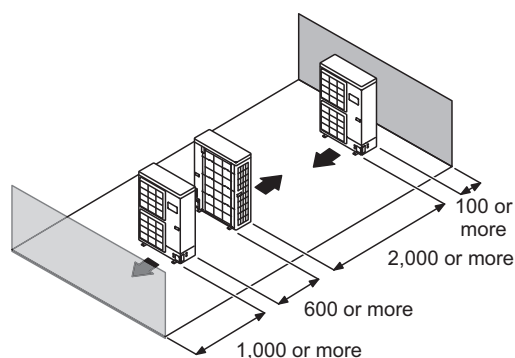

Multiple parallel unit arrangement

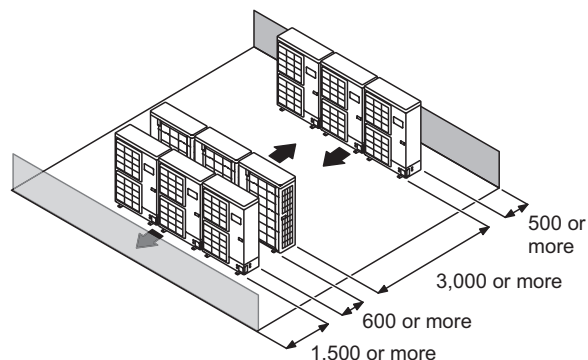

NOTES:

- If the space is larger than stated above, the condition will be the same as when there is no obstacle.
- Height above the floor level should be 50 mm or more.
- When installing the outdoor unit, be sure to open the front and left side to obtain better operation efficiency.

⚠ CAUTION

- When the outdoor temperature is 0 °C or less, do not use the accessory drain pipe and drain cap. If the drain pipe and drain cap are used, the drain water in the pipe may freeze in extremely cold climate. (For reverse cycle model only.)
- In area with heavy snowfall, if the inlet and outlet of the outdoor unit is blocked with snow, it might become difficult to get warm, and it is likely to cause product malfunction. Construct a canopy and a pedestal, or place the unit on a high stand that is locally installed.

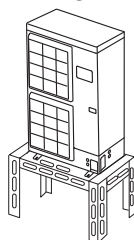

4. Piping diagrams

4-1. Models: WOYG160LJL, WOYK150LJL, and WOYK170LJL

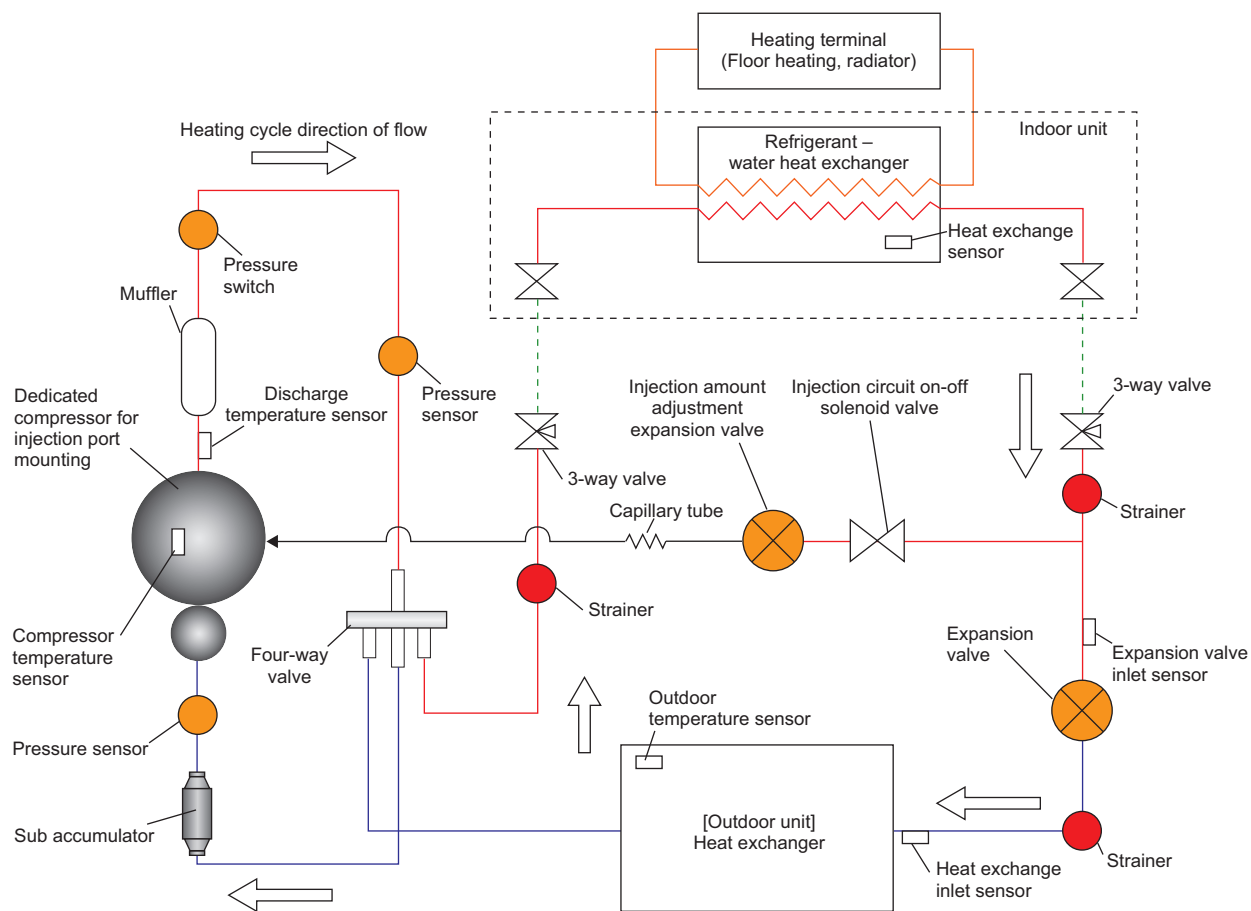

5-2. Models: WOYK150LJL and WOYK170LJL

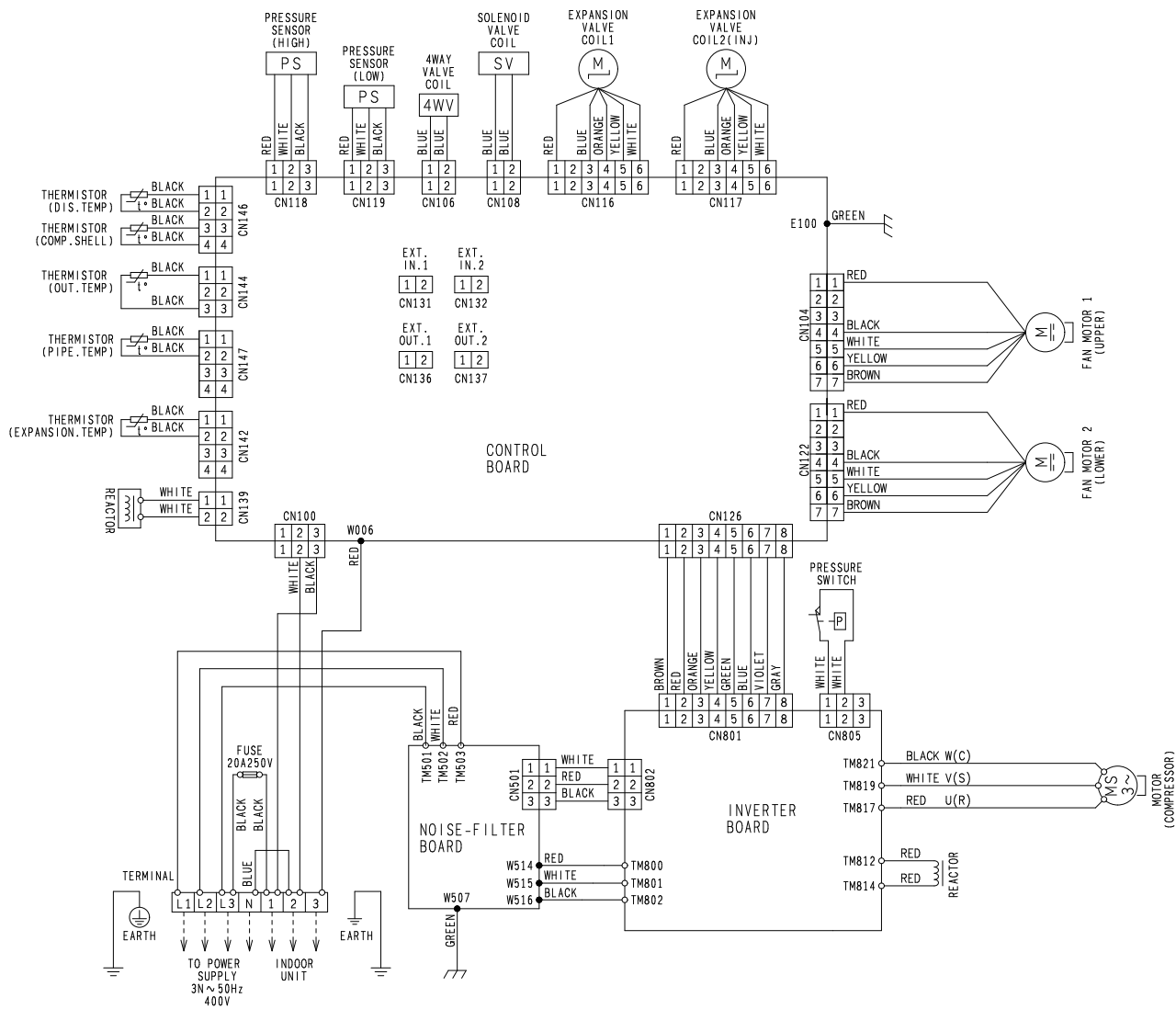

6. External input and output

With using external input and output functions, this product can be operated inter-connectedly with an external device.

Connector	Input	Output	Remarks
CN131	Low noise mode	—	See external input/output settings for details.
CN132	Peak cut mode	—	
CN136	—	Error status	
CN137	—	Compressor status	

6-1. External input

With using external input function, on/off status of “Low noise mode” and “Peak cut mode” can be specified by the external signal.

■ Low noise mode

In following condition, the operating noise of the outdoor unit reduces comparing from the one in normal operating condition:

The air conditioner is set to the “Low noise mode” when closing the contact input of a commercial timer or on/off switch to a connector on the control PCB of the outdoor unit.

NOTE: Product performance may drop depending on some conditions such as the outdoor temperature.

• Circuit diagram example (CN131)

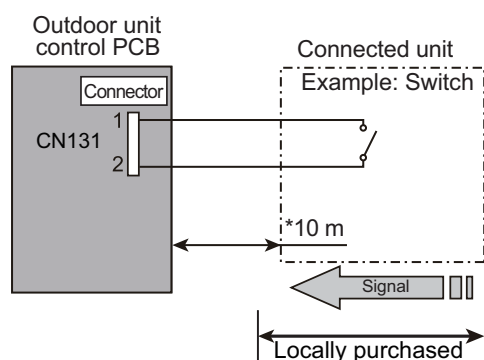

- Contact capacity: DC 24 V or more, 10 mA or more.
- *: Make the distance from the PCB to the connected unit within 10 m.
- Construct a circuit as shown in this figure with using optional parts mentioned below.
- Input signal: On in “Low noise mode”
- Input signal: Off in normal operation
- To set the level of “Low noise mode”, refer to ["Low noise mode"](#) on page 01-19.

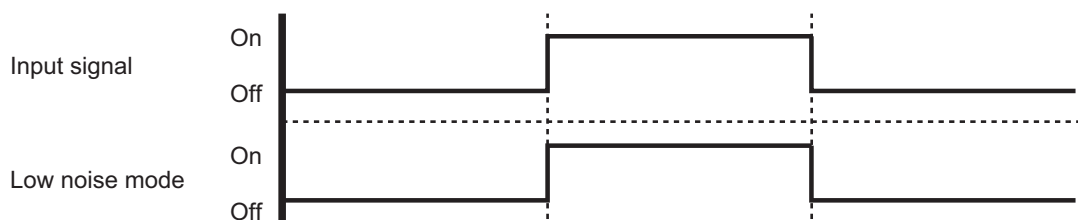

• Optional part

Part name	Model name	Exterior
External connect kit	UTY-XWZXZ3	

■ Peak cut mode

By performing following on-site work, operation that suppresses the current value can be enabled: The air conditioner is set to the “Peak cut mode” when closing the contact input of a commercial timer or on/off switch to a connector on the control PCB of the outdoor unit.

• Circuit diagram example (CN132)

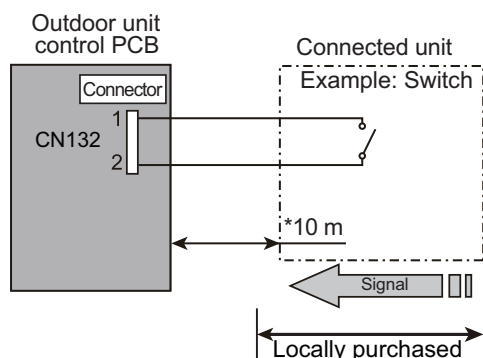

- Contact capacity: DC 24 V or more, 10 mA or more.
- *: Make the distance from the PCB to the connected unit within 10 m.
- Construct a circuit as shown in this figure with using optional parts mentioned below.
- Input signal: On in “Peak cut mode”
- Input signal: Off in normal operation
- To set the level of “Peak cut mode”, refer to "[Peak cut mode](#)" on page 01-20.

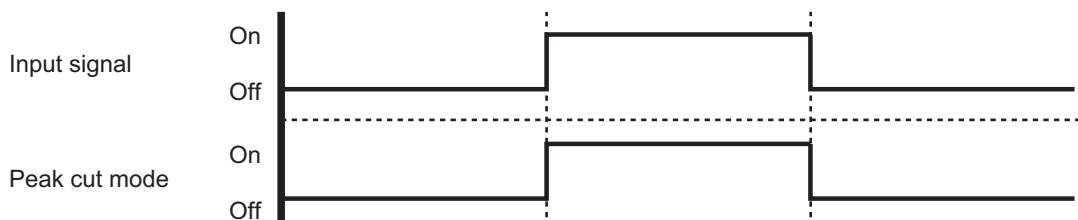

• Optional part

Part name	Model name	Exterior
External connect kit	UTY-XWZXZ3	

6-2. External output

With using external output function, some status signals are transmitted to the control PCB, and the related LED lamp indicates the status of this product.

■ Error status output

Signal on air conditioner error status is generated when a malfunction occurs.

• Circuit diagram example (CN136)

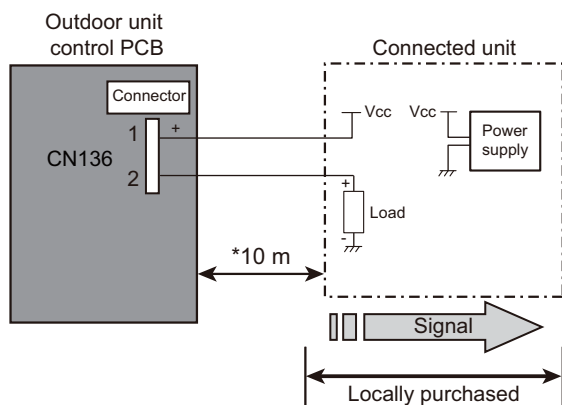

- 1: Power supply
Voltage (Vcc): DC 24 V or less
- 2: Load
DC 500 mA or less
- *: Make the distance from the PCB to the connected unit within 10 m.

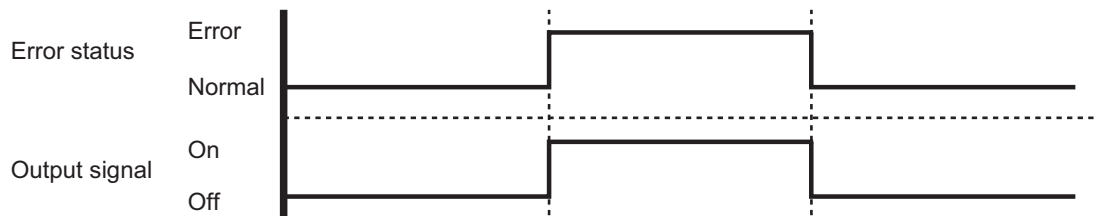

• Optional part

Part name	Model name	Exterior
External connect kit	UTY-XWZXZ3	

Compressor status output

Signal on compressor operation status is generated when the compressor is running.

- **Circuit diagram example (CN137)**

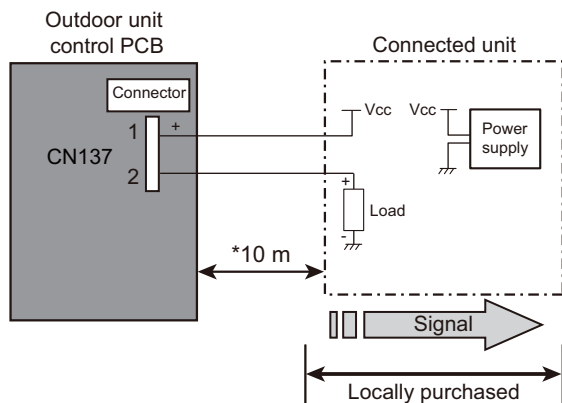

- 1: Power supply
Voltage (Vcc): DC 24 V or less
- 2: Load
DC 500 mA or less
- *: Make the distance from the PCB to the connected unit within 10 m.

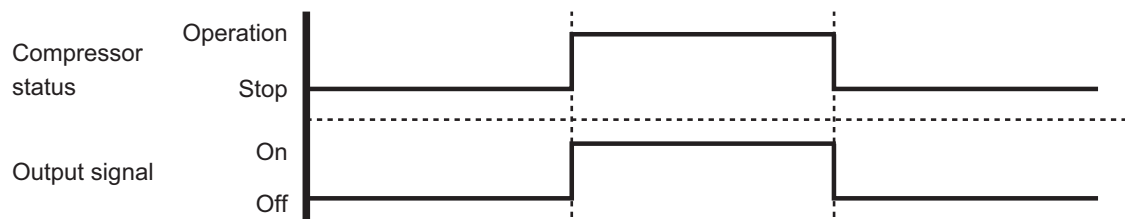

- **Optional part**

Part name	Model name	Exterior
External connect kit	UTY-XWZXZ3	

7. Function settings

Perform appropriate function setting locally according to the installation environment.

NOTE: Incorrect settings can cause a product malfunction.

⚠ CAUTION

- Before setting up the switch buttons, discharge the static electricity from your body.
- Never touch the terminals or the patterns on the parts that are mounted on the PCB.

7-1. Local setting switch buttons

■ Control PCB and switch buttons location

Control PCB of the outdoor unit is located as shown in the following figure.

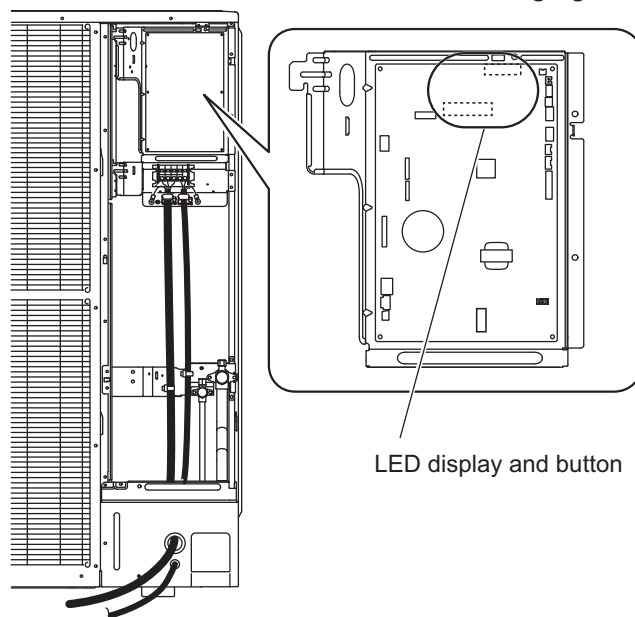

■ Switch buttons and the functions

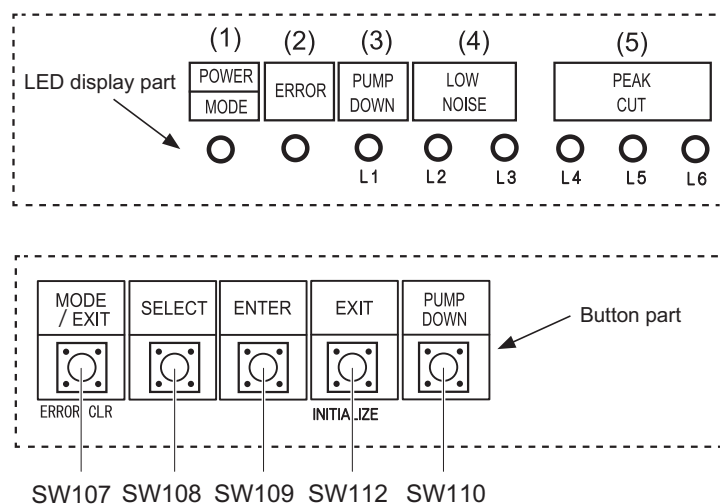

LED lamp			Function or operation method
(1)	POWER/MODE	Green	Lights on while power on. Local setting in outdoor unit or error code is displayed with blink.
(2)	ERROR	Red	Blinks during error operation.
(3)	PUMP DOWN (L1)	Orange	Lights on during pump down operation.
(4)	LOW NOISE MODE (L2 and L3)	Orange	Lights on during "Low noise mode" when local setting is activated. (Lighting pattern of L2 and L3 indicates low noise level.)
(5)	PEAK CUT MODE (L4, L5, and L6)	Orange	Lights on during "Peak cut mode" when local setting is activated. (Lighting pattern of L4, L5, and L6 indicates peak cut level.)

Switch button		Function or operation method
SW107	MODE	Switches between "Local setting" and "Error code display".
SW108	SELECT	Switches between the individual "Local settings" and the "Error code displays".
SW109	ENTER	Switches between the individual "Local settings" and the "Error code displays".
SW112	EXIT	Returns to "Operation status display".
SW110	PUMP DOWN	Starts the pump down operation.

Function setting table

No.	Setting item		LED display							Factory setting	
			POWER MODE	ERROR	PUMP DOWN	LOW NOISE		PEAK CUT			
					(L1)	(L2)	(L3)	(L4)	(L5)		(L6)
1	Low noise mode setting	Level 1	Blink (9 times)	○	○	○	●	○	○	●	◆
		Level 2		○	○	○	●	○	●	○	
2	Peak cut mode setting	Level 1		○	○	●	○	○	○	●	
		Level 2		○	○	●	○	○	●	○	
		Level 3		○	○	●	○	○	●	●	
		Level 4		○	○	●	○	●	○	○	◆

Sign "○": Lights off, "●": Lights on

No.	Setting item	Content
1	Low noise mode setting	By using the "Low noise mode", the limit of the noise level will be set to decrease the noise level. The mode comes in 2 levels which can be set accordingly. To turn on the mode, use the external input terminal (CN131). <ul style="list-style-type: none"> By using this mode, the cooling/heating performance may decrease. Depending on the operating condition, the noise level may not decrease even if the Low noise mode is on.
2	Peak cut mode setting	The capacity limit can be selected when operating with the "Peak Cut mode." The operation selection can be done by external input terminal (CN132). The lower the level, the more the effect of energy saving, but the cooling/heating performance decreases.

Model name			WOYG160LJL	WOYK150LJL	WOYK170LJL
Level1	Cooling	dB (A)			
	Heating				
Level2	Cooling	dB (A)			
	Heating				

7-2. Local setting procedure

NOTE: Before performing the function setting, be sure to stop the operation of the air conditioner.

Low noise mode

1. Press the MODE switch button (SW107) for 3 seconds or more to switch to “Local setting mode”.
2. After confirming the LED lamp of POWER/MODE blinks 9 times, press the ENTER switch button (SW109).

POWER MODE	ERROR	PUMP DOWN (L1)	LOW NOISE (L2) (L3)		PEAK CUT (L4) (L5) (L6)		
Blinks (9 times)	○	○	○	○	○	○	○

Sign “○”: Lights off

3. Press the SELECT switch button (SW108), and adjust the LED lamp as shown below. Then the LED lamp indicates the current setting.

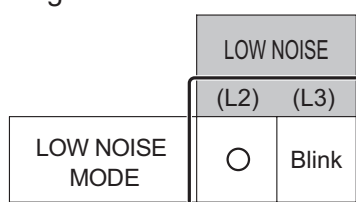

4. Press the ENTER switch button (SW109).

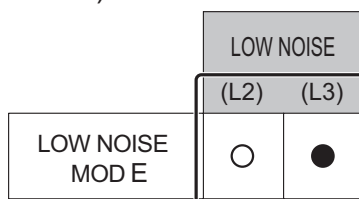

Sign “●”: Lights on

5. Press the SELECT switch button (SW108), and adjust the LED lamps as shown below.

		PEAK CUT (L4) (L5) (L6)		
Level 1	Low	○	○	Blink
Level 2	Lower	○	Blink	○

6. Press the ENTER switch button (SW109) and fix it.

		PEAK CUT (L4) (L5) (L6)		
Level 1	Low	○	○	●
Level 2	Lower	○	●	○

7. To return to “Operating status display (Normal operation)”, press the EXIT switch button (SW112).

In case of missing how many times you pressed the SELECT and ENTER switch buttons:

1. To return to “Operation status display (Normal operation)”, press the EXIT switch button once.
2. Restart from the beginning of setting procedure.

NOTE: In case of missing how many times you pressed the SELECT and ENTER switch buttons, you must redo the setting procedure. Return to “Operation status display (Normal operation)” by pressing the EXIT switch button once, and restart from the beginning of the setting procedure.

■ Peak cut mode

1. Press the MODE switch button (SW107) for 3 seconds or more to switch to “Local setting mode”.
2. After confirming the LED lamp of POWER/MODE blinks 9 times, press the ENTER switch button (SW109).

POWER MODE	ERROR	PUMP DOWN (L1)	LOW NOISE (L2) (L3)		PEAK CUT (L4) (L5) (L6)		
Blinks (9 times)	○	○	○	○	○	○	○

Sign “○”: Lights off

3. Press the SELECT switch button (SW108), and adjust the LED lamp as shown below. Then the LED lamp indicates the current setting.

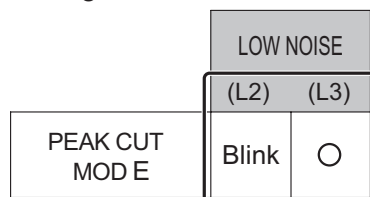

4. Press the ENTER switch button (SW109).

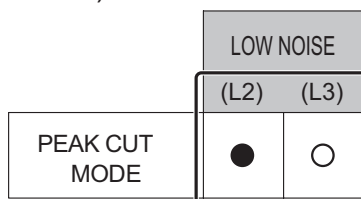

Sign “●”: Lights on

5. Press the SELECT switch button (SW108), and adjust the LED lamps as shown below.

		PEAK CUT (L4) (L5) (L6)		
Level 1	0% of rated input ratio	○	○	Blink
Level 2	50% of rated input ratio	○	Blink	○
Level 3	75% of rated input ratio	○	Blink	Blink
Level 4	100% of rated input ratio	Blink	○	○

Sign “○”: Lights off

6. Press the ENTER switch button (SW109) and fix it.

		PEAK CUT (L4) (L5) (L6)		
Level 1	0% of rated input ratio	○	○	●
Level 2	50% of rated input ratio	○	●	○
Level 3	75% of rated input ratio	○	●	●
Level 4	100% of rated input ratio	●	○	○

Sign “○”: Lights off, “●”: Lights on

7. To return to “Operating status display (Normal operation)”, press the EXIT switch button (SW112).

NOTE: When pressed number is lost during setting, you must redo the setting procedure. Return to “Operation status display (Normal operation)” by pressing the EXIT switch button once, and restart from the beginning of the setting procedure.

8. Heating capacity table

- FT: Flow temperature
- OT: Outdoor temperature
- HC: Heating capacity (kW)
- IP: Input power (kW)
- COP: Coefficient Of Performance
- Usage environment, such as operation of the heating equipment, room temperature, and control adjustments may cause disparities between practically determined and measured values.
- Values mentioned in the table are calculated based on the maximum capacity without defrost.

8-1. Model: WOYG160LJL

FT	30°C			35°C			40°C			45°C			50°C			55°C			60°C		
OT	HC	IP	COP	HC	IP	COP	HC	IP	COP	HC	IP	COP	HC	IP	COP	HC	IP	COP	HC	IP	COP
-25°C	8.18	4.09	2.00	8.37	4.58	1.83	8.55	5.07	1.69	8.74	5.56	1.57	8.61	5.93	1.45	—	—	—	—	—	—
-20°C	10.91	4.91	2.22	10.73	5.24	2.05	10.55	5.58	1.89	10.37	5.91	1.75	9.91	6.01	1.65	9.06	6.11	1.48	7.95	6.13	1.30
-15°C	13.15	5.14	2.56	12.76	5.41	2.36	12.35	5.69	2.17	11.92	5.97	2.00	11.24	6.04	1.86	10.25	6.10	1.68	9.00	6.04	1.49
-10°C	15.38	5.36	2.87	14.80	5.58	2.65	14.16	5.81	2.44	13.47	6.03	2.23	12.58	6.06	2.08	11.43	6.10	1.87	10.13	6.03	1.68
-7°C	16.72	5.50	3.04	16.01	5.68	2.82	15.24	5.87	2.60	14.39	6.06	2.37	13.37	6.08	2.20	12.14	6.09	1.99	10.80	6.03	1.79
-5°C	17.62	5.59	3.15	16.83	5.75	2.93	15.96	5.92	2.70	15.01	6.08	2.47	13.91	6.09	2.28	12.62	6.09	2.07	11.24	6.04	1.86
0°C	19.85	5.81	3.42	18.86	5.92	3.19	17.76	6.03	2.95	16.56	6.14	2.70	15.24	6.11	2.49	13.80	6.08	2.27	12.35	6.08	2.03
5°C	22.43	5.84	3.84	21.31	5.95	3.58	19.93	6.00	3.32	18.51	6.05	3.06	16.86	6.03	2.80	14.99	6.01	2.49	13.37	6.01	2.22
7°C	23.46	5.85	4.01	22.93	5.98	3.83	20.79	5.99	3.47	19.28	6.01	3.21	17.50	5.99	2.92	15.46	5.98	2.59	13.78	5.98	2.30
10°C	25.00	5.87	4.26	23.75	5.98	3.97	22.09	5.97	3.70	20.45	5.95	3.44	18.47	5.94	3.11	16.17	5.93	2.73	14.39	5.93	2.43
15°C	25.77	5.46	4.72	24.40	5.51	4.43	22.55	5.51	4.09	20.44	5.47	3.74	17.88	5.44	3.29	16.18	5.41	2.99	14.11	5.36	2.63
20°C	26.54	5.04	5.27	25.05	5.04	4.97	23.01	5.04	4.57	20.42	4.99	4.09	17.28	4.93	3.51	16.18	4.88	3.32	13.83	4.78	2.89
25°C	26.82	5.02	5.34	25.19	4.99	5.05	23.20	4.93	4.71	20.84	4.92	4.24	18.11	4.91	3.69	15.02	4.90	3.07	13.62	4.88	2.79
30°C	28.22	4.97	5.68	26.48	4.96	5.34	24.56	4.93	4.98	22.46	4.92	4.57	18.64	4.91	3.80	15.47	4.89	3.16	13.97	4.88	2.86
35°C	29.61	4.92	6.02	27.76	4.92	5.64	25.92	4.92	5.27	24.07	4.92	4.89	19.16	4.90	3.91	15.91	4.87	3.27	14.31	4.88	2.93

NOTE: The values mentioned in the table are calculated based on the maximum capacity:

- FT < 45°C: The flow rate obtained during the test at the standard rating conditions of OT 7°C and Water temp. flow/return 35°C / 30°C, 2,773 l/h
- FT ≥ 45°C: The flow rate obtained during the test at the standard rating conditions of OT 7°C and Water temp. flow/return 45°C / 30°C, 2,653 l/h
- FT ≥ 55°C: The flow rate obtained during the test at the standard rating conditions of OT 7°C and Water temp. flow/return 55°C / 30°C, 1,583 l/h

8-2. Model: WOYK150LJL

OUTDOOR
UNITOUTDOOR
UNIT

FT	30°C			35°C			40°C			45°C			50°C			55°C			60°C		
OT	HC	IP	COP	HC	IP	COP	HC	IP	COP	HC	IP	COP	HC	IP	COP	HC	IP	COP	HC	IP	COP
-25°C	7.68	3.62	2.12	7.86	4.07	1.93	8.02	4.48	1.79	8.20	4.91	1.67	8.09	5.25	1.54	—	—	—	—	—	—
-20°C	10.23	4.35	2.35	10.06	4.66	2.16	9.89	4.97	1.99	9.72	5.28	1.84	9.40	5.56	1.69	8.99	5.84	1.54	7.43	5.38	1.38
-15°C	12.32	4.55	2.71	12.05	4.88	2.47	11.80	5.20	2.27	11.54	5.50	2.10	11.19	5.83	1.92	10.78	6.13	1.76	9.20	5.82	1.58
-10°C	14.40	4.75	3.03	14.05	5.07	2.77	13.70	5.42	2.53	13.38	5.74	2.33	12.97	6.09	2.13	12.55	6.44	1.95	10.20	6.00	1.70
-7°C	15.65	4.88	3.21	15.24	5.20	2.93	14.84	5.56	2.67	14.47	5.88	2.46	14.05	6.24	2.25	13.62	6.58	2.07	11.20	6.18	1.81
-5°C	16.49	4.95	3.33	16.04	5.28	3.04	15.61	5.64	2.77	15.20	5.98	2.54	14.77	6.37	2.32	14.34	6.70	2.14	12.02	6.13	1.96
0°C	18.58	5.15	3.61	18.03	5.50	3.28	17.51	5.86	2.99	17.02	6.21	2.74	16.55	6.62	2.50	16.11	7.00	2.30	13.10	6.24	2.10
5°C	21.58	5.33	4.05	21.02	5.71	3.68	20.47	6.11	3.35	19.95	6.48	3.08	18.17	6.42	2.83	16.48	6.41	2.57	13.59	5.81	2.34
7°C	22.77	5.40	4.22	22.67	5.78	3.92	21.66	6.22	3.48	21.13	6.58	3.21	18.81	6.35	2.96	16.62	6.18	2.69	13.78	5.60	2.46
10°C	24.57	5.50	4.47	24.01	5.93	4.05	23.44	6.35	3.69	22.88	6.73	3.40	19.77	6.26	3.16	16.83	5.78	2.91	14.07	5.33	2.64
15°C	24.97	5.04	4.95	23.81	5.27	4.52	22.64	5.50	4.12	21.48	5.67	3.79	19.04	5.44	3.50	16.70	5.22	3.20	13.50	4.74	2.85
20°C	25.35	4.59	5.52	23.59	4.61	5.12	21.84	4.61	4.74	20.08	4.61	4.36	18.32	4.61	3.97	16.56	4.61	3.59	12.93	4.16	3.11
25°C	25.50	4.23	6.03	24.05	4.27	5.63	22.24	4.29	5.18	20.05	4.25	4.72	17.49	4.19	4.17	14.57	4.15	3.51	12.95	4.14	3.13
30°C	26.82	4.22	6.36	25.16	4.24	5.94	23.32	4.26	5.47	21.29	4.25	5.01	17.71	4.19	4.23	14.74	4.14	3.56	13.22	4.18	3.16
35°C	28.15	4.27	6.60	26.27	4.20	6.25	24.40	4.23	5.77	22.52	4.23	5.32	17.91	4.19	4.27	14.91	4.14	3.60	13.49	4.23	3.19

NOTE: The values mentioned in the table are calculated based on the maximum capacity:

- FT < 45°C: The flow rate obtained during the test at the standard rating conditions of OT 7°C and Water temp. flow/return 35°C / 30°C, 2,599 l/h
- FT ≥ 45°C: The flow rate obtained during the test at the standard rating conditions of OT 7°C and Water temp. flow/return 45°C / 30°C, 2,453 l/h
- FT ≥ 55°C: The flow rate obtained during the test at the standard rating conditions of OT 7°C and Water temp. flow/return 55°C / 30°C, 1,441 l/h

8-3. Model: WOYK170LJL

FT	30°C			35°C			40°C			45°C			50°C			55°C			60°C		
OT	HC	IP	COP	HC	IP	COP	HC	IP	COP	HC	IP	COP	HC	IP	COP	HC	IP	COP	HC	IP	COP
-25°C	8.22	3.93	2.09	8.41	4.40	1.91	8.59	4.86	1.77	8.78	5.33	1.65	8.66	5.69	1.52	—	—	—	—	—	—
-20°C	10.95	4.71	2.32	10.77	5.05	2.13	10.59	5.39	1.96	10.41	5.73	1.82	10.06	6.03	1.67	9.63	6.32	1.52	7.95	5.84	1.36
-15°C	13.19	4.93	2.68	12.90	5.28	2.44	12.63	5.63	2.24	12.36	5.98	2.07	11.98	6.32	1.90	11.54	6.64	1.74	9.85	6.27	1.56
-10°C	15.42	5.15	2.99	15.04	5.51	2.73	14.67	5.87	2.50	14.32	6.23	2.30	13.89	6.60	2.10	13.44	6.97	1.93	10.78	6.39	1.69
-7°C	16.76	5.28	3.17	16.32	5.64	2.89	15.89	6.01	2.64	15.49	6.38	2.43	15.04	6.77	2.22	14.58	7.16	2.04	11.70	6.50	1.80
-5°C	17.66	5.36	3.29	17.17	5.73	3.00	16.71	6.11	2.73	16.27	6.48	2.51	15.81	6.89	2.29	15.35	7.29	2.11	12.87	6.65	1.94
0°C	19.89	5.58	3.56	19.31	5.96	3.24	18.75	6.35	2.95	18.22	6.73	2.71	17.72	7.17	2.47	17.25	7.61	2.27	14.03	6.79	2.07
5°C	23.10	5.77	4.00	22.51	6.20	3.63	21.92	6.63	3.31	21.36	7.02	3.04	19.45	6.98	2.79	17.64	6.95	2.54	14.55	6.29	2.31
7°C	24.38	5.85	4.17	24.27	6.27	3.87	23.19	6.74	3.44	22.62	7.13	3.17	20.14	6.90	2.92	17.79	6.68	2.66	14.75	6.08	2.43
10°C	26.31	5.96	4.41	25.71	6.43	4.00	25.10	6.90	3.64	24.50	7.30	3.36	21.17	6.79	3.12	18.02	6.28	2.87	15.06	5.78	2.61
15°C	26.73	5.47	4.89	25.49	5.71	4.46	24.24	5.95	4.07	23.00	6.15	3.74	20.39	5.90	3.46	17.88	5.65	3.16	14.45	5.15	2.81
20°C	27.14	4.98	5.45	25.26	4.99	5.06	23.38	5.00	4.68	21.50	5.00	4.30	19.61	5.01	3.92	17.73	5.01	3.54	13.84	4.51	3.07
25°C	27.30	4.59	5.95	25.75	4.63	5.56	23.81	4.66	5.11	21.47	4.60	4.66	18.73	4.55	4.12	15.60	4.49	3.47	13.86	4.49	3.09
30°C	28.72	4.57	6.28	26.94	4.60	5.86	24.97	4.62	5.40	22.79	4.60	4.95	18.96	4.54	4.18	15.78	4.49	3.51	14.15	4.54	3.12
35°C	30.14	4.55	6.52	28.13	4.56	6.17	26.12	4.58	5.70	24.11	4.59	5.25	19.18	4.54	4.22	15.96	4.49	3.55	14.44	4.58	3.15

NOTE: The values mentioned in the table are calculated based on the maximum capacity:

- FT < 45°C: The flow rate obtained during the test at the standard rating conditions of OT 7°C and Water temp. flow/return 35°C / 30°C, 2,946 l/h
- FT ≥ 45°C: The flow rate obtained during the test at the standard rating conditions of OT 7°C and Water temp. flow/return 45°C / 30°C, 2,784 l/h
- FT ≥ 55°C: The flow rate obtained during the test at the standard rating conditions of OT 7°C and Water temp. flow/return 55°C / 30°C, 1,638 l/h

9. Cooling capacity table

- For cooling operation optional parts of Cooling kit is necessary.
- FT: Flow temperature
- OT: Outdoor temperature
- CC: Cooling capacity (kW)
- IP: Input power (kW)
- EER: Energy Efficiency Ratio
- Usage environment, such as operation of the heating equipment, room temperature, and control adjustments may cause disparities between practically determined and measured values.

9-1. Model: WOYG160LJL

FT	7°C			10°C			13°C			15°C			18°C			22°C		
OT	CC	IP	EER	CC	IP	EER	CC	IP	EER	CC	IP	EER	CC	IP	EER	CC	IP	EER
20°C	9.96	3.49	2.85	11.95	3.84	3.11	13.82	4.12	3.35	15.00	4.26	3.52	16.67	4.41	3.78	18.70	4.48	4.17
25°C	9.89	3.95	2.50	11.84	4.23	2.80	13.65	4.45	3.07	14.78	4.56	3.24	16.36	4.68	3.50	18.26	4.75	3.84
30°C	9.20	4.15	2.22	11.08	4.51	2.46	12.82	4.79	2.68	13.90	4.93	2.82	15.18	4.92	3.09	17.21	5.13	3.35
35°C	8.50	4.34	1.96	10.31	4.78	2.16	11.98	5.12	2.34	13.02	5.29	2.46	14.00	5.15	2.72	16.16	5.50	2.94
40°C	8.05	4.70	1.71	9.16	4.72	1.94	10.27	4.74	2.17	11.00	4.75	2.32	12.11	4.77	2.54	13.59	4.80	2.83
46°C	7.00	4.70	1.49	7.92	4.73	1.67	8.84	4.74	1.86	9.45	4.75	1.99	10.38	4.75	2.19	11.62	4.74	2.45

NOTE: The values mentioned in the table are calculated based on the maximum capacity:

- FT < 10°C: The flow rate obtained during the test at the standard rating conditions of OT 35°C and Water temp. flow/return 7°C / 12°C, 1,464 l/h
- FT ≥ 10°C: The flow rate obtained during the test at the standard rating conditions of OT 35°C and Water temp. flow/return 18°C / 23°C, 2,416 l/h

9-2. Model: WOYK150LJL

FT	7°C			10°C			13°C			15°C			18°C			22°C		
OT	CC	IP	EER	CC	IP	EER	CC	IP	EER	CC	IP	EER	CC	IP	EER	CC	IP	EER
20°C	9.61	3.30	2.91	11.61	3.54	3.28	13.50	3.72	3.63	14.68	3.82	3.84	16.37	3.90	4.20	18.41	3.94	4.67
25°C	9.51	3.71	2.56	11.34	3.87	2.93	13.09	4.00	3.27	14.21	4.07	3.49	15.84	4.13	3.84	17.89	4.18	4.28
30°C	9.01	3.91	2.30	10.69	4.12	2.59	12.31	4.30	2.86	13.37	4.39	3.05	14.93	4.40	3.39	16.87	4.56	3.70
35°C	8.50	4.11	2.07	10.03	4.37	2.30	11.53	4.59	2.51	12.52	4.71	2.66	14.00	4.66	3.00	15.83	4.94	3.20
40°C	7.96	4.57	1.74	9.15	4.62	1.98	10.34	4.66	2.22	11.15	4.70	2.37	12.38	4.74	2.61	14.02	4.80	2.92
46°C	7.10	4.84	1.47	8.13	4.86	1.67	9.13	4.84	1.89	9.78	4.81	2.03	10.73	4.74	2.26	11.94	4.60	2.60

NOTE: The values mentioned in the table are calculated based on the maximum capacity:

- FT < 10°C: The flow rate obtained during the test at the standard rating conditions of OT 35°C and Water temp. flow/return 7°C / 12°C, 1,464 l/h
- FT ≥ 10°C: The flow rate obtained during the test at the standard rating conditions of OT 35°C and Water temp. flow/return 18°C / 23°C, 2,416 l/h

9-3. Model: WOYK170LJL

FT	7°C			10°C			13°C			15°C			18°C			22°C		
OT	CC	IP	EER	CC	IP	EER	CC	IP	EER	CC	IP	EER	CC	IP	EER	CC	IP	EER
20°C	10.17	3.52	2.89	12.22	3.80	3.22	14.12	4.01	3.52	15.30	4.12	3.71	16.95	4.23	4.01	18.92	4.29	4.41
25°C	10.07	3.96	2.54	11.93	4.15	2.87	13.69	4.31	3.18	14.81	4.39	3.37	16.41	4.48	3.66	18.38	4.55	4.04
30°C	9.54	4.18	2.28	11.25	4.42	2.55	12.88	4.63	2.78	13.93	4.74	2.94	15.46	4.77	3.24	17.33	4.97	3.49
35°C	9.00	4.39	2.05	10.56	4.69	2.25	12.06	4.94	2.44	13.04	5.08	2.57	14.50	5.05	2.87	16.27	5.38	3.02
40°C	8.43	4.88	1.73	9.63	4.95	1.95	10.82	5.02	2.16	11.62	5.07	2.29	12.82	5.14	2.49	14.41	5.23	2.76
46°C	7.52	5.17	1.45	8.56	5.21	1.64	9.55	5.21	1.83	10.19	5.19	1.96	11.11	5.14	2.16	12.27	5.01	2.45

NOTE: The values mentioned in the table are calculated based on the maximum capacity:

- FT < 10°C: The flow rate obtained during the test at the standard rating conditions of OT 35°C and Water temp. flow/return 7°C / 12°C, 1,550 l/h
- FT ≥ 10°C: The flow rate obtained during the test at the standard rating conditions of OT 35°C and Water temp. flow/return 18°C / 23°C, 2,503 l/h

10. Operation noise (sound pressure)

10-1. Noise level curve

■ Model: WOYG160LJL

● Heating

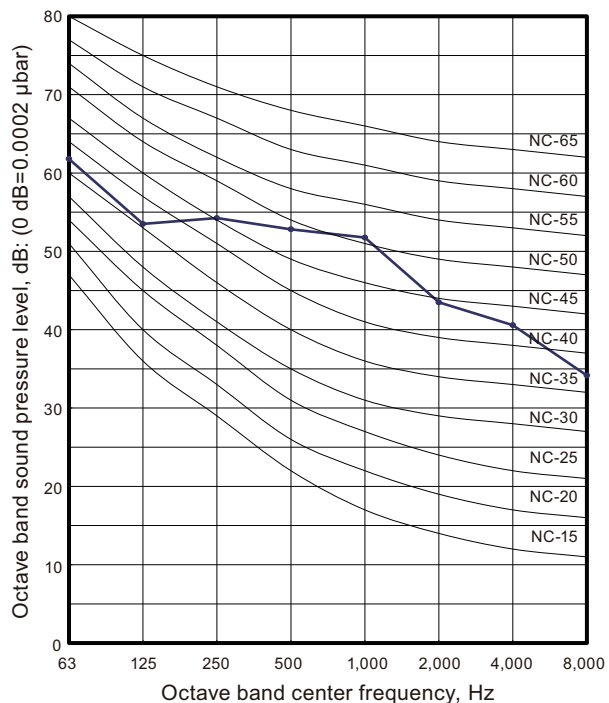

■ Model: WOYK150LJL

● Heating

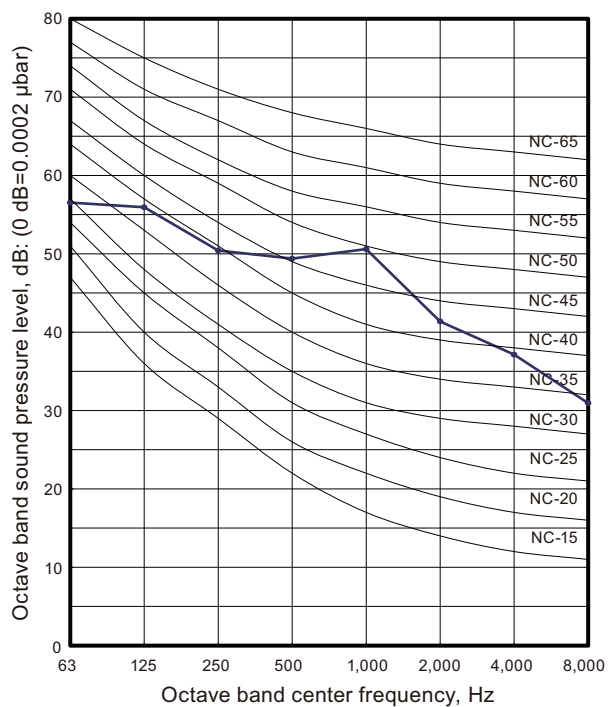

■ Model: WOYK170LJL

● Heating

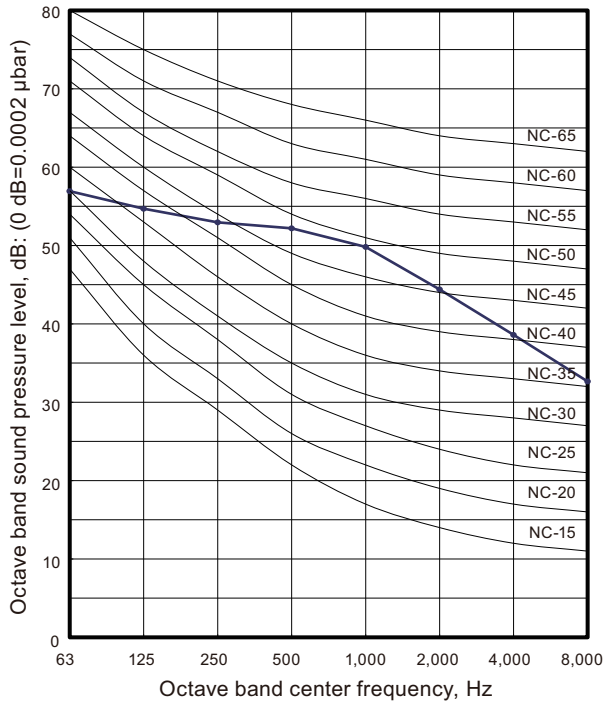

10-2. Sound level check point

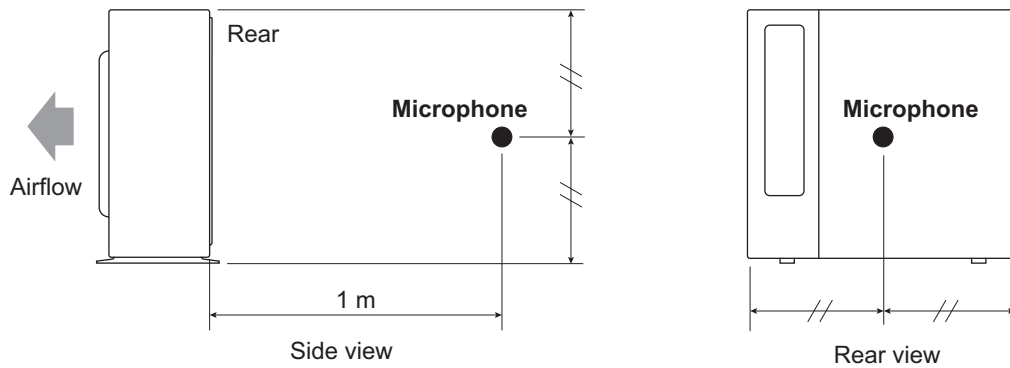

NOTE: Detailed shape of the actual outdoor unit might be slightly different from the one illustrated above.

11. Operation range



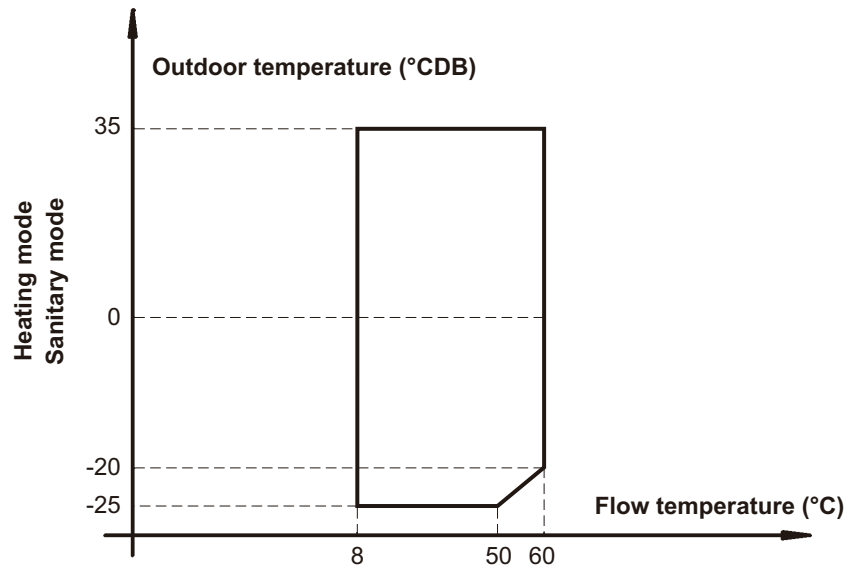
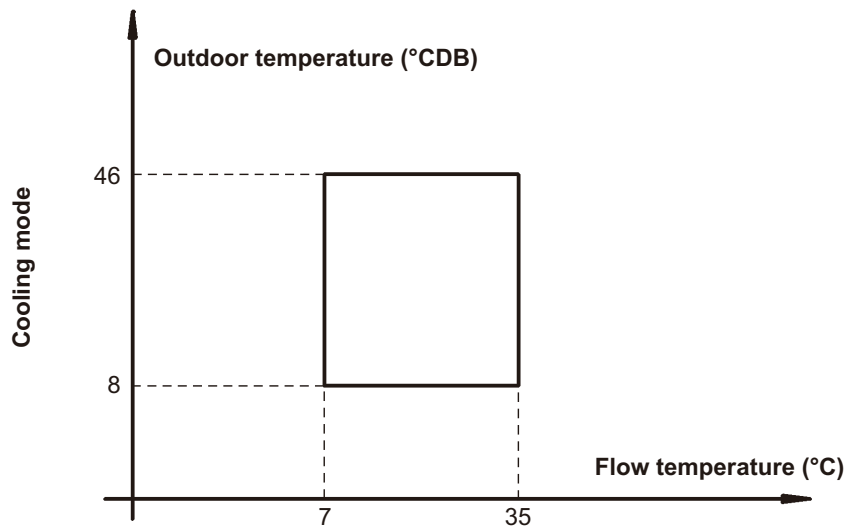



11-1. Models: WOYG160LJL, WOYK150LJL, and WOYK170LJL



12. Safety devices

Type of protection	Protection form		Model		
			WOYG160LJL	WOYK150LJL	WOYK170LJL
Circuit protection	Current fuse (Main PCB)		AC 250 V, 10 A		
	Current fuse (Filter PCB)		AC 500 V, 25 A × 3		
	Current fuse (Side of the terminal)		AC 250 V, 20 A		
Fan motor protection	Thermal protector	Activate	115±15 °C Fan motor stop		
		Reset	70 °C Fan motor restart		
Compressor protector	Compressor temperature protection	Activate	112 °C Compressor stop		
		Reset	80 °C Compressor restart		
	Discharge pipe temperature protection	Activate	115 °C Compressor stop		
		Reset	After 7 minutes Compressor restart		
High pressure protection	Pressure switch	Activate	4.2 ⁺⁰ _{-0.15} MPaG Compressor stop		
		Reset	3.2±0.15 MPaG Compressor restart		
	Pressure sensor	Activate	4.2 MPa Compressor stop		
		Reset	3.2 MPa Compressor restart		
Low pressure protection (Cooling mode only)	Pressure sensor	Activate	0.12 MPa Compressor stop		
		Reset	0.15 MPa Compressor restart		

13. Accessories

Name and shape	Q'ty	Application
 <p>Installation manual</p>	1	
 <p>Drain cap</p>	9	For outdoor unit drain piping work
 <p>Drain pipe</p>	1	For outdoor unit drain piping work
 <p>Joint pipe B-L</p>	1	For connecting gas pipe (L type)
 <p>Push mount cable tie</p>	2	For binding transmission cable
 <p>Grommet edging</p>	2	For power supply cable end connection cable installation. Attach to the knockout hole.



2. HYDRAULIC INDOOR UNITS

CONTENTS

2. HYDRAULIC INDOOR UNITS

1. Specifications	02-1
1-1. Technical specifications.....	02-1
1-2. Electrical specifications.....	02-1
2. Dimensions	02-2
2-1. Models: WSYG160DJ6 and WSYK170DJ9.....	02-2
3. Installation space	02-3
3-1. Models: WSYG160DJ6 and WSYK170DJ9.....	02-3
3-2. Installation precautions.....	02-3
4. Piping diagrams	02-4
4-1. Models: WSYG160DJ6 and WSYK170DJ9.....	02-4
5. Wiring diagrams	02-5
5-1. Models: WSYG160DJ6 and WSYK170DJ9.....	02-5
6. External connection diagrams	02-6
6-1. Models: WSYG160DJ6 and WSYK170DJ9.....	02-6
7. Hydraulic performance	02-7
7-1. Models: WSYG160DJ6 and WSYK170DJ9.....	02-7
8. Safety devices	02-8
9. Accessories	02-9

1. Specifications

1-1. Technical specifications

Model name		Hydraulic indoor unit		WSYG160DJ6	WSYK170DJ9	
		Outdoor unit		WOYG160LJL	WOYK150LJL	WOYK170LJL
Input power	Heating	Rated	kW	0.08		
		Maximum*1		9		
Enclosure		Material	8/10 mm DC01 + EZ (5μ)			
		Color	White			
Dimensions (H × W × D)	Net		mm	805 × 450 × 471		
	Gross			970 × 560 × 560		
Weight	Net		kg	52.5		
	Gross			56		
Water capacity				22		
Main components	Pump	Type	Water cooled			
		Speed setting	Variable pressure/Constant pressure			
	Input power*3		W	70		
				Type	Double tube	
	Water side heat exchanger	Q'ty		1		
		Water volume	l	22		
		Min. water flow rate	L/h	1,170	1,460	1,650
	Nominal water flow rate	Heating	L/h	1,872	2,339	2,629
		Cooling		1,691	2,157	2,330
	Expansion vessel	Insulation material		Polyurethane		
Volume		l	10			
Max. water pressure		bar	4.5			
Pre-pressure	1 (±20%)					
Water circuit	Piping connection diameter		mm (in)	Ø25.4 (1)		
	Piping			Ø25.4 (1)		
	Safety valve		bar	3		
	Manometer			Yes		
	Drain valve/Fill valve		Yes			
	Air purge valve		Yes			
Connection pipe (Refrigerant circuit)	Connection method	Liquid	mm	Flare connection		
		Gas		Flare connection		
	Size	Liquid	mm	Ø9.52 (3/8)		
		Gas		Ø15.88 (5/8)		
Operation range	Water side	Heating	°C	8 to 60		
Pump rank				A		
NOTES:						
• *1: With electric backup heater						
• *2: The value is at full speed and full flow.						

1-2. Electrical specifications

Model name		Hydraulic indoor unit		WSYG160DJ6	WSYK170DJ9	
		Outdoor unit		WOYG160LJL	WOYK150LJL	WOYK170LJL
Electrical heater	Type			Stainless steel 303 L 9.5 W/cm ²		
	Power supply	Phase			3	
		Frequency	Hz	50		
		Voltage	V	400		
	Current	Running current			7.9	
Max. operating current (Hydraulic indoor unit)		A	10 (+10%)			
Wiring spec.	Backup heater power supply	Main fuse (circuit breaker) current	A	20		
	Hydraulic indoor unit to outdoor unit	Connection cable	mm ²	2.5 × 4		
		Connection cable	mm ²	1.5 × 4		
	Limited wiring length	m	Not available			

2. Dimensions

2-1. Models: WSYG160DJ6 and WSYK170DJ9

Unit: mm

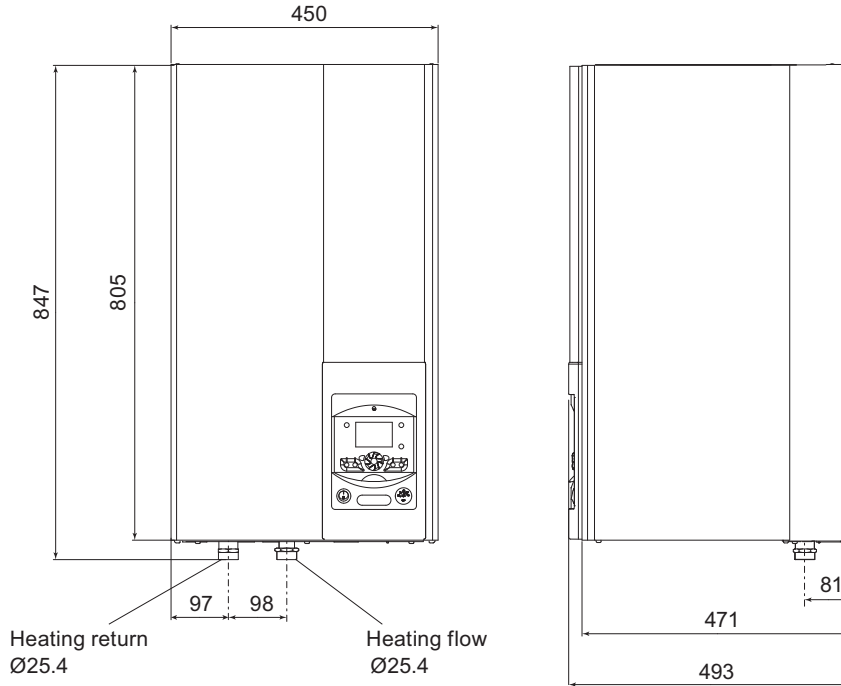

Front view

Side view

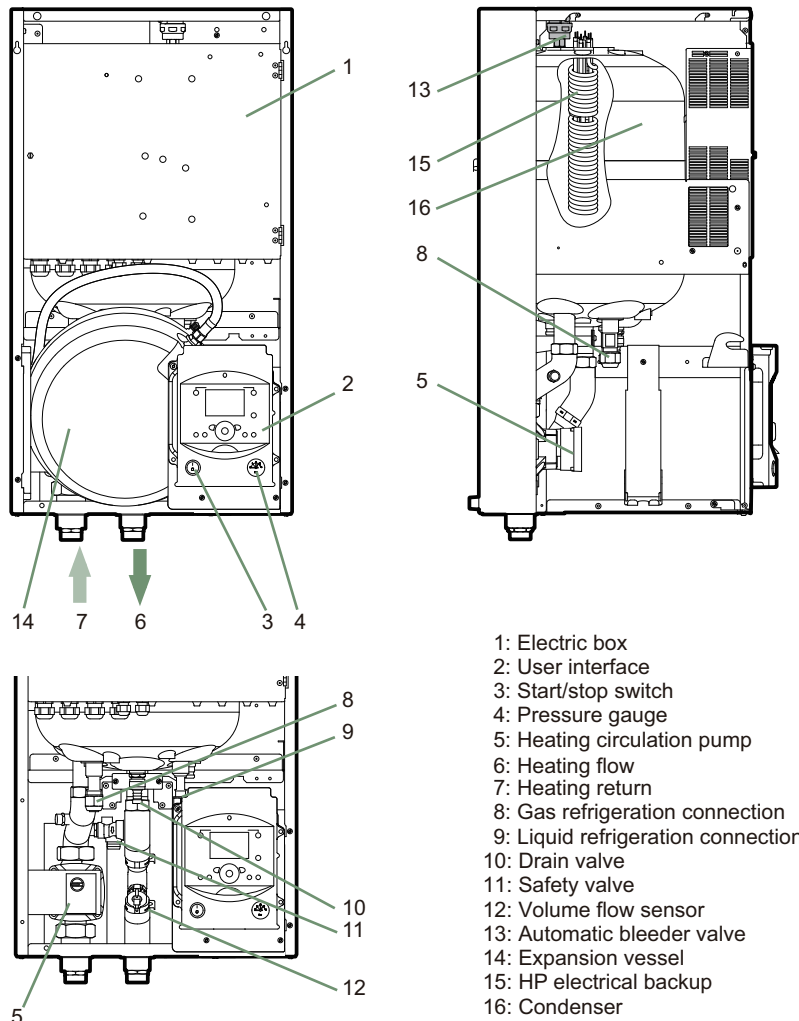

- 1: Electric box
- 2: User interface
- 3: Start/stop switch
- 4: Pressure gauge
- 5: Heating circulation pump
- 6: Heating flow
- 7: Heating return
- 8: Gas refrigeration connection
- 9: Liquid refrigeration connection
- 10: Drain valve
- 11: Safety valve
- 12: Volume flow sensor
- 13: Automatic bleeder valve
- 14: Expansion vessel
- 15: HP electrical backup
- 16: Condenser

3. Installation space

3-1. Models: WSYG160DJ6 and WSYK170DJ9

Unit: mm

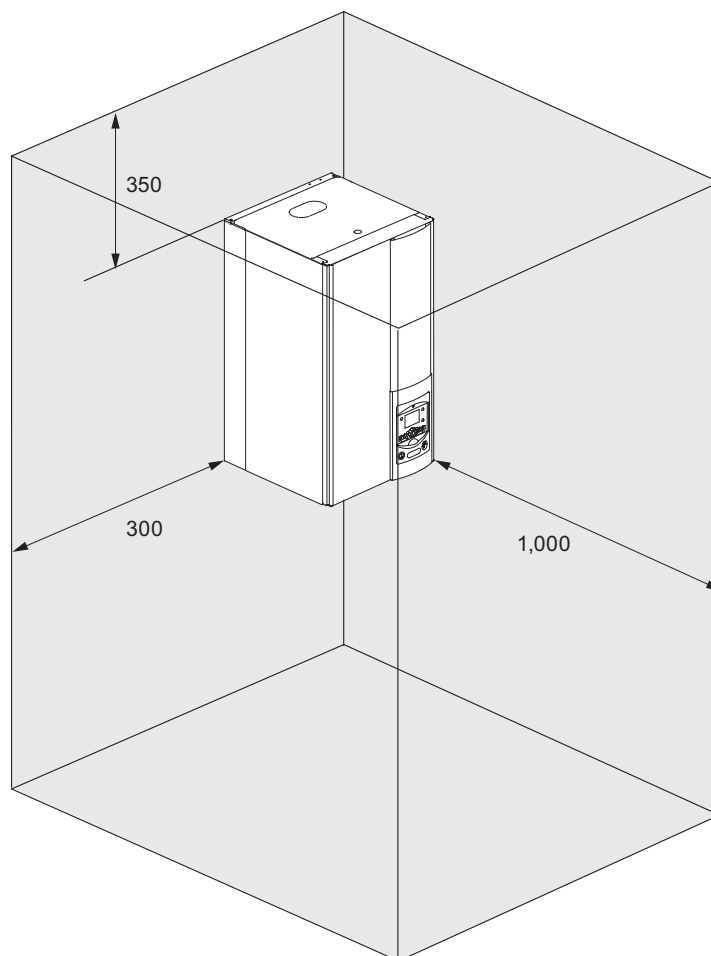

3-2. Installation precautions

- The room in which the appliance operates must comply with the prevailing regulations.
- To facilitate maintenance and to allow access to the various components, we recommend that you provide sufficient space all around the hydraulic module.
- Be careful not to bring inflammable gas near to the heat pump during its installation, in particular when it requires brazing. The appliances are not fireproof and should not therefore be installed in a potentially explosive atmosphere.

4. Piping diagrams

4-1. Models: WSYG160DJ6 and WSYK170DJ9

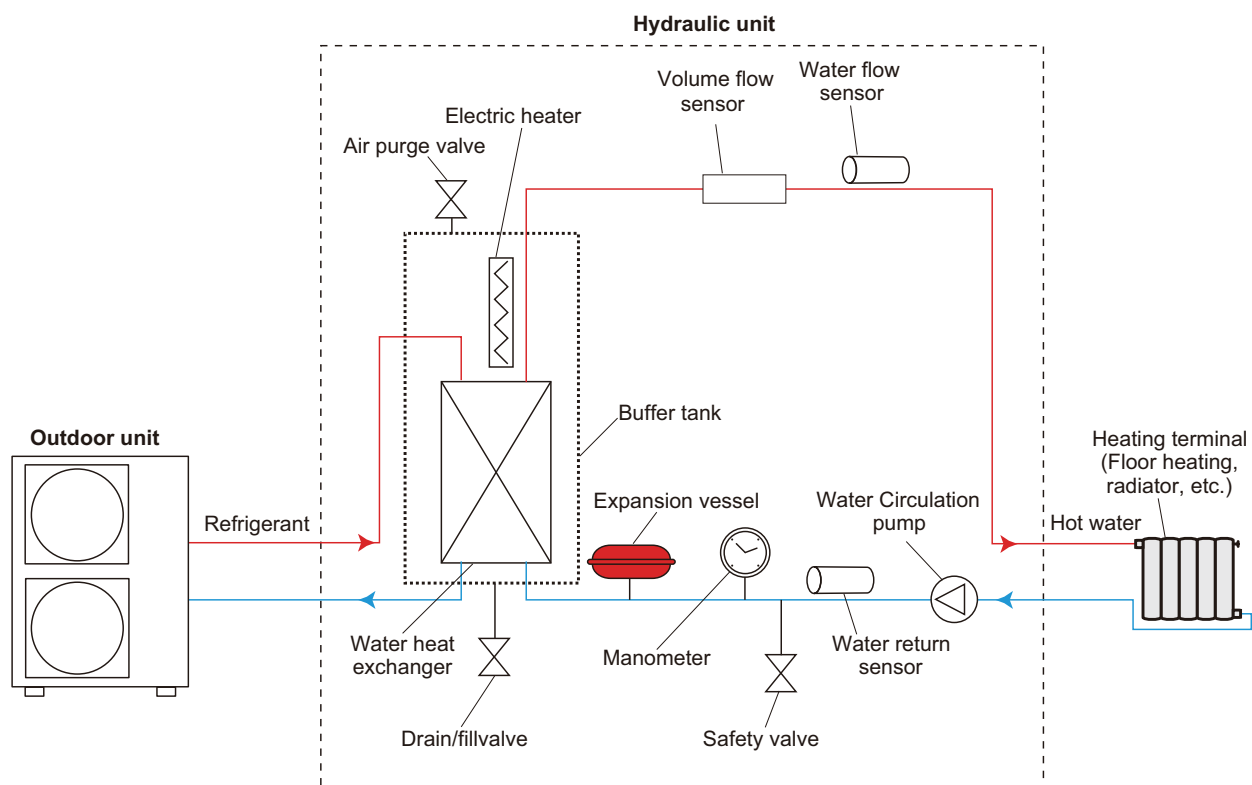

HYDRAULIC
INDOOR UNITS

HYDRAULIC
INDOOR UNITS

5. Wiring diagrams

5-1. Models: WSYG160DJ6 and WSYK170DJ9

HYDRAULIC
INDOOR UNITS

HYDRAULIC
INDOOR UNITS

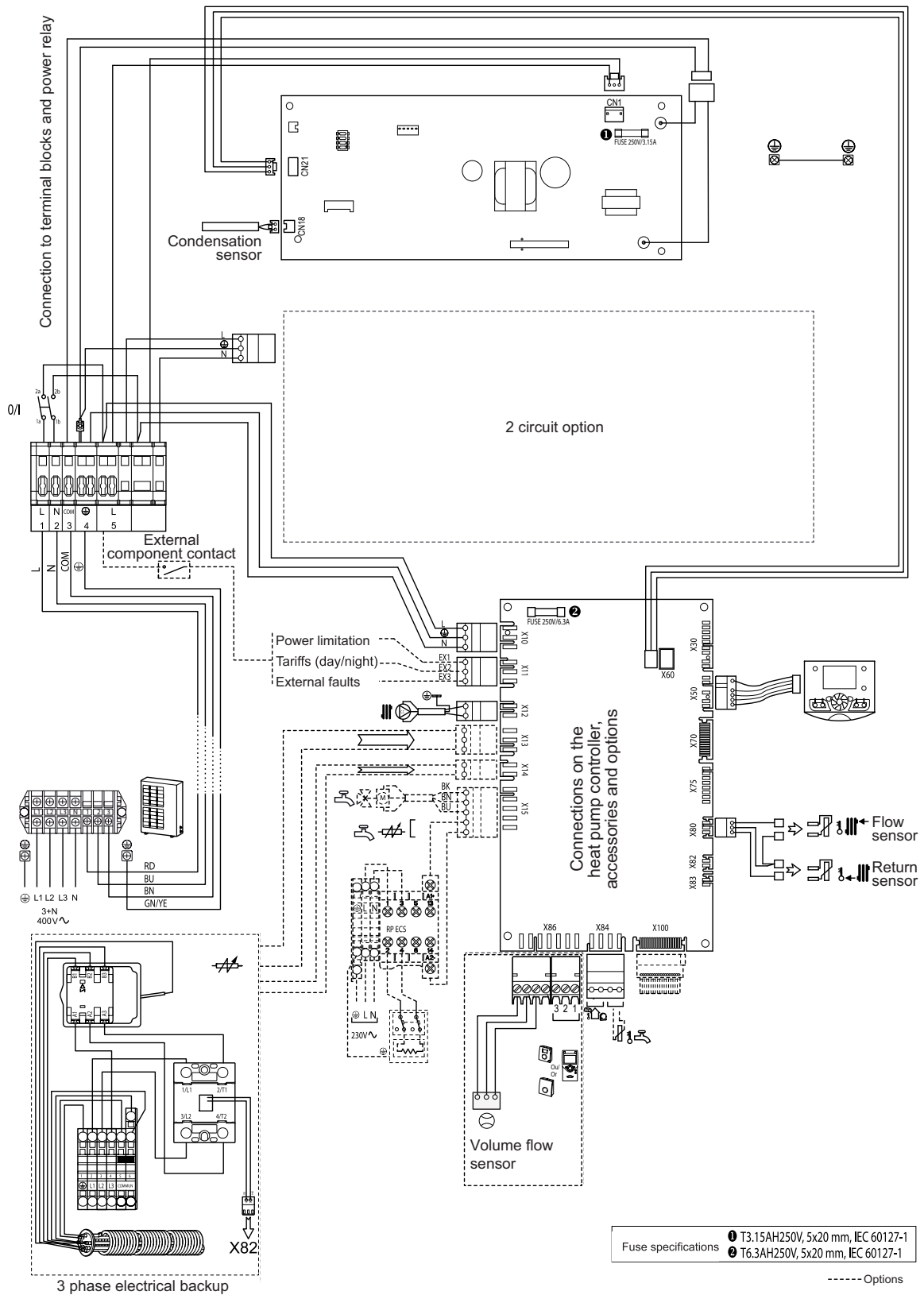

6. External connection diagrams

6-1. Models: WSYG160DJ6 and WSYK170DJ9

HYDRAULIC
INDOOR UNITS

HYDRAULIC
INDOOR UNITS

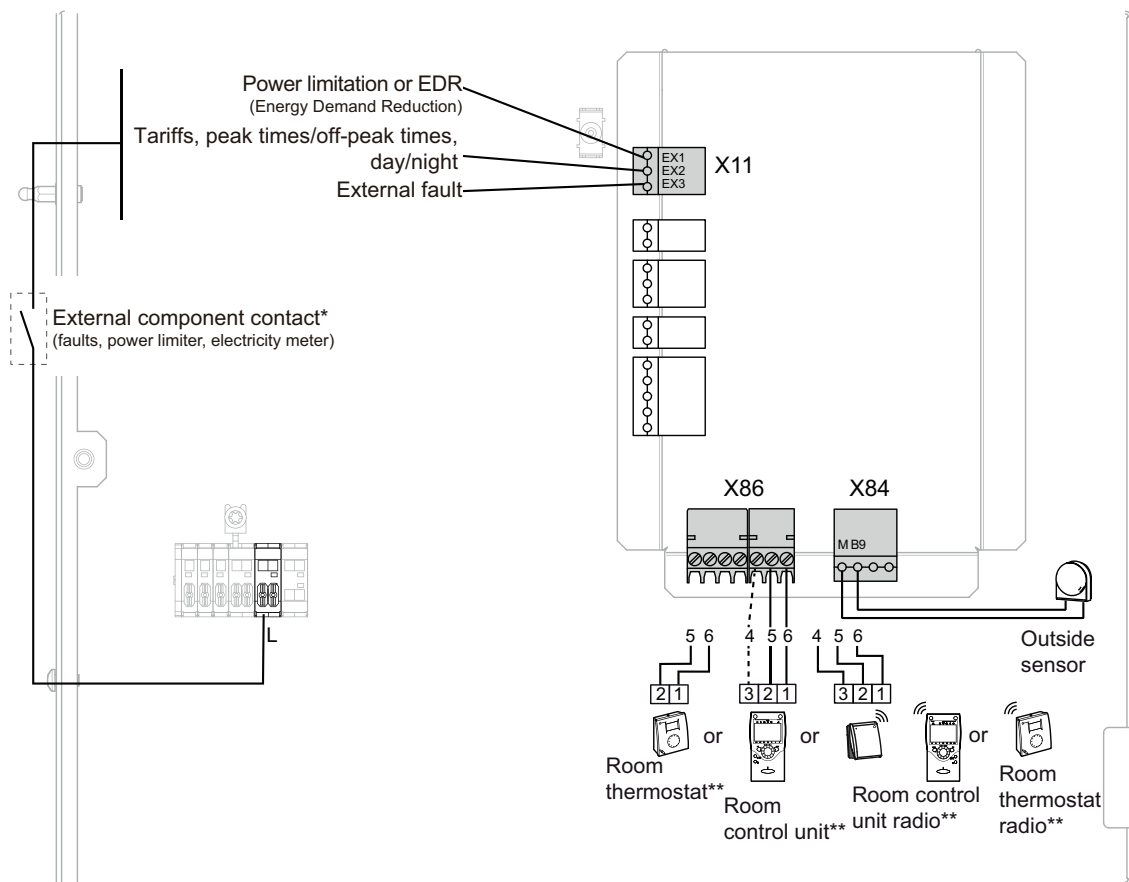

* If the control device does not provide a potential-free contact, the contact must be relayed to create equivalent wiring. In all cases, refer to the instruction manuals for the external components (load shedder, power meters) to create the wiring.

** Option

The connection of terminal 3 of the room control unit is not mandatory (lighting of the room control unit).

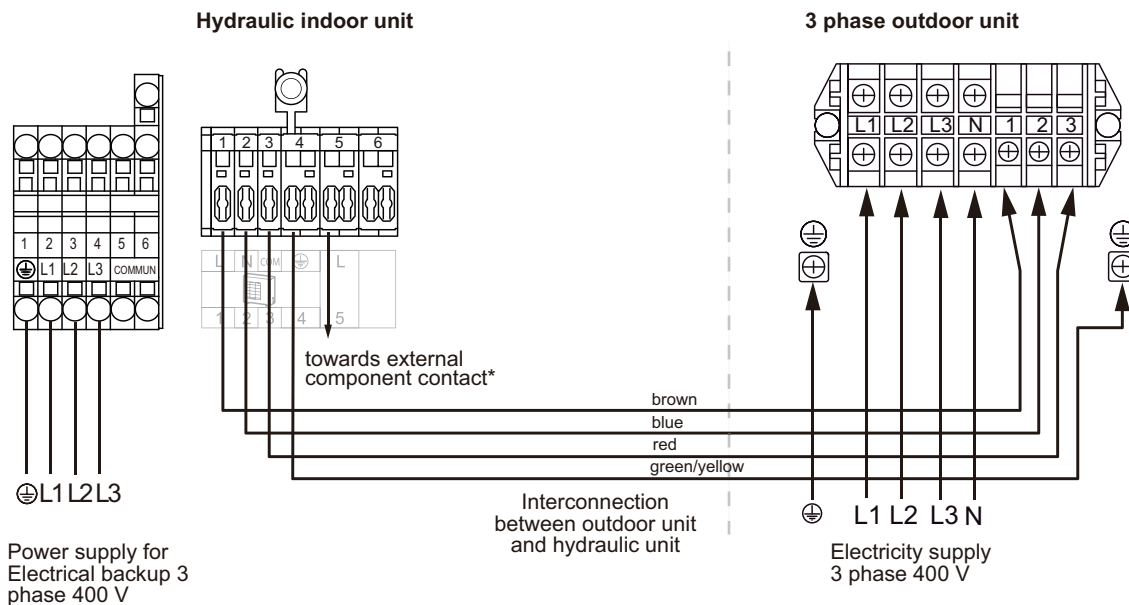

7. Hydraulic performance

7-1. Models: WSYG160DJ6 and WSYK170DJ9

HYDRAULIC INDOOR UNITS

HYDRAULIC INDOOR UNITS

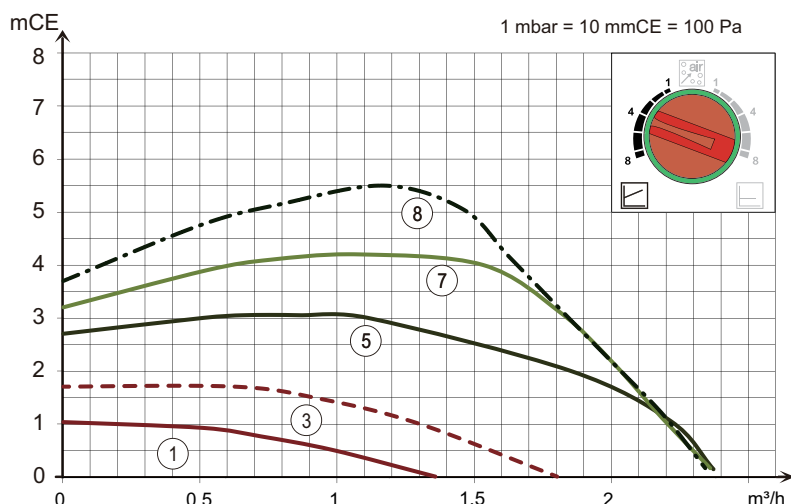

Variable pressure

The circulation pump varies the water pressure depending on the flow rate.

Recommended for an installation fitted with radiators (particularly any system with thermostatic valves or zone solenoids).

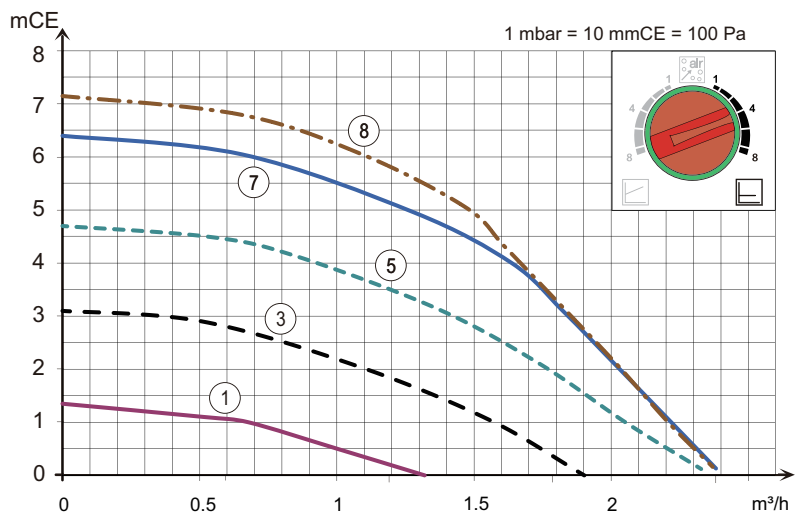
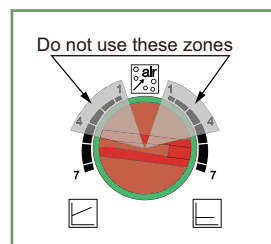

Constant pressure

The circulation pump maintains a constant water pressure whatever the flow rate.







Recommended for an installation with constant pressure drops such as an underfloor heating system.

	OFF	LED Off: The circulation pump is not working, no power supply.
		Green LED On: The circulation pump is operating normally.
	10 min.	Green LED flashing: Venting mode in operation (10 minutes).
	Auto Test	Red/Green LED flashing: Operating error with automatic restart.
		Red LED flashing: Operating error.

8. Safety devices

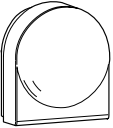
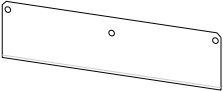
Type of protection	Protection form		Model	
			WSYG160DJ6	WSYK170DJ9
Circuit protection	Current fuse (Main PCB)		20 A	
High pressure protection	Safety valve	Activate	3 bar or more Safety valve open	
		Reset	—	

9. Accessories

Name and shape	Q'ty	Application
 Installation manual	1	
 Operation manual	5	
 Outdoor sensor	1	To monitor the outdoor temperature
 Bracket	1	To secure the hydraulic model
 Adapter (small)	1	To connect the flared connection and the hydraulic model
 Adapter (large)	1	
 Nut (small)	1	
 Nut (large)	1	



3. CONTROL SYSTEM







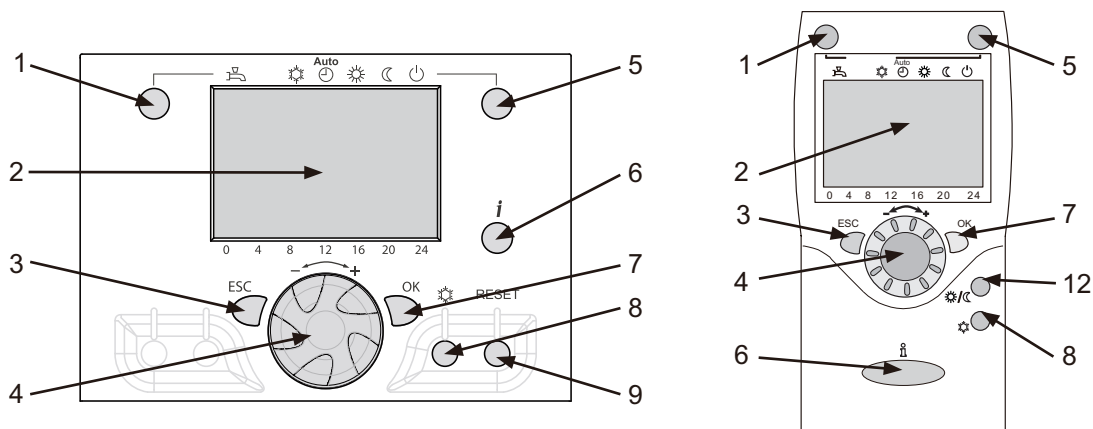

CONTENTS

3. CONTROL SYSTEM

1. User interface and remote controller (Optional parts)	03-1
2. Control setting	03-6
2-1. General.....	03-6
2-2. Setting parameters	03-6
3. Function table	03-7
3-1. Time of day and date	03-7
3-2. Operator section	03-8
3-3. Time program functions	03-9
3-4. Heating circuit 1 and 2 functions.....	03-12
3-5. Cooling circuit 1 functions.....	03-23
3-6. Domestic hot water functions.....	03-31
3-7. Swimming pool functions	03-35
3-8. Heat pump functions.....	03-36
3-9. Energy meter	03-38
3-10. Additional generator (Boiler connection).....	03-40
3-11. DHW storage tank functions	03-42
3-12. Installation configuration functions.....	03-44
3-13. LPB system	03-49
3-14. Error functions	03-49
3-15. Service/Special operation functions.....	03-52
3-16. Input/Output test functions.....	03-54
3-17. State functions.....	03-57
3-18. Diagnostics heat generation functions	03-61
3-19. Diagnostics consumers functions	03-63
4. Electrical connections	03-66
4-1. Overview of all the electrical connections	03-66
4-2. Electrical connections on the hydraulic indoor unit	03-67
4-3. Connections to the heat pump regulator (Accessories and Options).....	03-70
5. Outdoor sensor	03-77
5-1. Model: QAC34	03-77

1. User interface and remote controller (Optional parts)



Ref.	Function	Definition
1	Selecting DHW operating mode (Domestic hot water)  : On  : Off	If the installation is fitted with a DHW tank <ul style="list-style-type: none"> On: Production of DHW according to the time program Off: Preparing the domestic hot water for stopping with the anti-frost function active Manual start button: Hold down the DHW key for 3 seconds. Switch from “reduced” to “comfort” until the next time the DHW timer switches over.
2	Digital display	<ul style="list-style-type: none"> Operating control Readout of the current temperature, the heating mode and any faults△. View the settings (Info section)
3	Exit “ESC”	Quit the menu.
4	Navigation and setting	<ul style="list-style-type: none"> Selecting the menu Setting parameters Adjusting the ambient temperature point
5	Selecting heating mode	<ul style="list-style-type: none"> : Heating operation according to the heating program (Summer/Winter mode switchover is automatic.) : Constant comfort temperature : Constant reduced temperature : Standby mode with anti-frost protection (Provided that the heat pump’s electrical power supply is not interrupted.)
6	Info key	<ul style="list-style-type: none"> Various data For details, refer to "Various data of information display" on page 03-2. NOTE: Ensure that the general electrical power supply has been cut off before starting any repair work. When the HP is not under tension, protection frost-free is not assured. △ Reading error codes For details, refer to "Error codes" on page 03-3.  Information concerning maintenance, special mode
7	Confirm “OK”	<ul style="list-style-type: none"> Input into the selected menu. Confirmation of the parameter settings Confirmation of the adjustment to the comfort temperature setting
8	Selecting cooling mode	If the installation is fitted with the cooling kit: <ul style="list-style-type: none"> : Cooling operation according to the heating program (Summer/Winter mode switchover is automatic.)
9	RESET button Hold down the “RESET” key for less than 3 seconds.	Reinitializing the parameters and canceling error messages. Do not use during normal operation.
12	Presence key	Comfort/Reduced switchover

■ Various data of information display

Designation	Line
Floor drying current setpoint	—
Current drying day	—
Terminated drying days	—
State heat pump	8006
State supplementary source	8022
State DHW	8003
State swimming pool	8011
State heating circuit 1	8000
State heating circuit 2	8001
State cooling circuit 1	8004
Outside temperature	8700
Room temperature 1	8740
Room setpoint 1	
Flow temperature 1	8743
Flow temperature setpoint 1	
Room temperature 2	8770
Room setpoint 2	
Flow temperature 2	8773
Flow temperature setpoint 2	
DHW (domestic hot water) temperature	8830
DHW (domestic hot water) temperature setpoint	
Return temperature HP	8410
Setpoint (return) HP	
Flow temperature HP	8412
Setpoint (flow) HP	
Swimming pool temperature	8900
Swimming pool temperature setpoint	
Minimum remaining stop time for compressor 1	—
Minimum remaining running time for compressor 1	—

■ Error codes

- **Hydraulic indoor unit:** Fault visible on the digital display

Error number	Error contents	Error location	Reset		Heat pump operation
			Manual	Auto	
10	Outdoor sensor	X84	No	No	Yes
30	Flow sensor mixing circuit	X153	No	No	Yes
33	Flow sensor HP	X70	No	No	Yes
44	Return sensor HP	X70	No	No	Yes
50	DHW sensor 1	X84	No	No	Yes
60	Room sensor 1	X86	No	No	Yes
65	Room sensor 2	X150	No	No	Yes
83	BSB, Short circuit		No	No	Yes
105	Maintenance message		No	No	Yes
121	Flow temperature mixing circuit (too low)		No	No	Yes
122	Flow temperature direct circuit (too low)		No	No	Yes
127	Legionella temperature		No	No	Yes
212	Internal communication failure		No	No	Yes
369	External fault (Safety component)	X11 (EX3)	No	No	No
370	Thermodynamic source*		No	No	No
441	BX31 no function		No	No	No
442	BX24 no function		No	No	No
443	BX33 no function		No	No	No
444	BX34 no function		No	No	No
516	Heat pump missing		No	No	No
—	No connection	The polarity of the room sensor is not respected.	—	—	No

*: A fault in the outdoor unit is indicated by LED located on the hydraulic unit interface board.

- **Hydraulic indoor unit:** A fault in the outdoor unit is indicated by LED located on the hydraulic unit interface board.

LED		Error contents
LED 2 (Green)	LED 1 (Red)	
1 Flash	1 Flash	Communication error between Hydraulic unit and Outdoor unit
2 Flashes	3 Flashes	Connection forbidden (series error)
3 Flashes	1 Flash	Indoor unit power supply abnormal
3 Flashes	2 Flashes	Serial communication error between controller PCB and interface PCB
4 Flashes	1 Flash	Heat pump capacity signal error (Open or short)
4 Flashes	2 Flashes	Hydraulic indoor unit heat exchanger thermistor error
6 Flashes	1 Flash	Outdoor unit power supply abnormal
6 Flashes	2 Flashes	Outdoor unit main PCB error
6 Flashes	3 Flashes	Inverter error
6 Flashes	4 Flashes	Active filter error
6 Flashes	5 Flashes	Outdoor unit IPM error
6 Flashes	7 Flashes	Outdoor unit power short interruption error (protective operation)
6 Flashes	8 Flashes	Outdoor unit magnetic relay error
7 Flashes	1 Flash	Discharge thermistor error
7 Flashes	2 Flashes	Compressor thermistor error
7 Flashes	3 Flashes	Heat exchanger thermistor (outlet/intermediate) error
7 Flashes	4 Flashes	Outdoor thermistor error
7 Flashes	7 Flashes	Outdoor unit heat sink temperature thermistor error
7 Flashes	8 Flashes	Expansion valve thermistor error
8 Flashes	4 Flashes	Current sensor error
8 Flashes	6 Flashes	Pressure sensor error/Pressure switch error
9 Flashes	4 Flashes	Current trip
9 Flashes	5 Flashes	Detection of compressor position error/Compressor start up error
9 Flashes	7 Flashes	Outdoor unit fan motor 1 error
9 Flashes	8 Flashes	Outdoor unit fan motor 2 error
10 Flashes	1 Flash	Discharge temperature protection
10 Flashes	3 Flashes	Compressor temperature protection
10 Flashes	4 Flashes	Outdoor unit pressure error
10 Flashes	5 Flashes	Low pressure abnormal
10 Flashes	9 Flashes	Current overload error
Continuous flashing (1 sec On / 1 sec Off)		Pump down operation
Continuous lighting	Off	Defrosting

- **Outdoor unit:**

To access the electronic board, the front (right-side) facing from outdoor unit must be removed. Faults are coded by LED flashes.

Switches and LED location on the outdoor unit

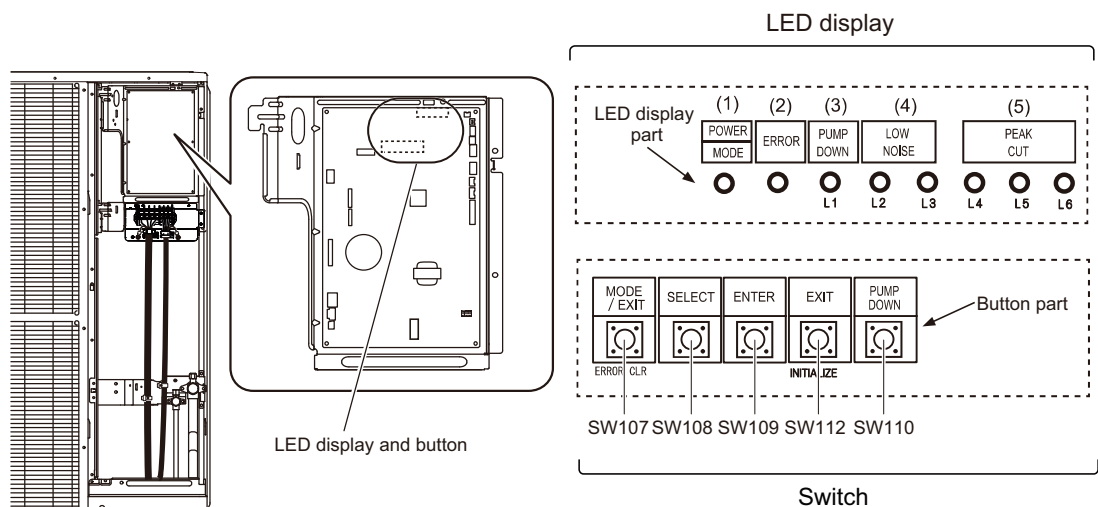

When an error occurs:

- Check that the LED of ERROR blinks, and then press shortly the switch of ENTER.
- The LED of POWER MODE will blink twice and LED of ERROR will blink several time. For details, refer to the table below.

LED display	Error contents
1 Flash	Serial forward transfer error
2 Flashes	Discharge thermistor error
3 Flashes	Pressure sensor error
4 Flashes	Heat-exchange thermistor (outlet) error
6 Flashes	Expansion valve thermistor error
7 Flashes	Outdoor temperature thermistor error
8 Flashes	Compressor thermistor error
9 Flashes	Heat sink thermistor error
10 Flashes	—
11 Flashes	Discharge temperature protection (permanent stoppage)
12 Flashes	Compressor temperature protection (permanent stoppage)
13 Flashes	Current trip (permanent stoppage)
14 Flashes*	Detection of compressor position error (permanent stoppage)
15 Flashes	Compressor start up error (permanent stoppage)
16 Flashes	Fan motor (1) error (permanent stoppage)
17 Flashes	Fan motor (2) error (permanent stoppage)
18 Flashes	Inverter error
20 Flashes	Low pressure abnormal
23 Flashes	Discharge pressure sensor error
24 Flashes	Suction pressure sensor error

*: 3-phase outdoor unit only

2. Control setting

2-1. General

The settings described below are those which can be modified by user. We wish to remind you that changing the settings below may cause the heat pump to behave in an undesirable way. A testing period should be conducted before the permanent settings of the heat pump are confirmed. This may require a number of changes to be made by the installer.

There are 4 access levels:

- U: End user level
- I: Commissioning level (installer start-up)
- S: Engineer level (specialist)
- C: OEM level (manufacturer) (not available)

2-2. Setting parameters

- Choose the desired level.
- Scroll the menu list.
- Choose the desired menu.
- Scroll the function line.
- Choose the desired line.
- Adjust the parameter.
- Check the setting by pressing OK.
- To return the menu, press ESC.

NOTE: If no setting is made for 8 minutes, the screen returns automatically to the basic display.

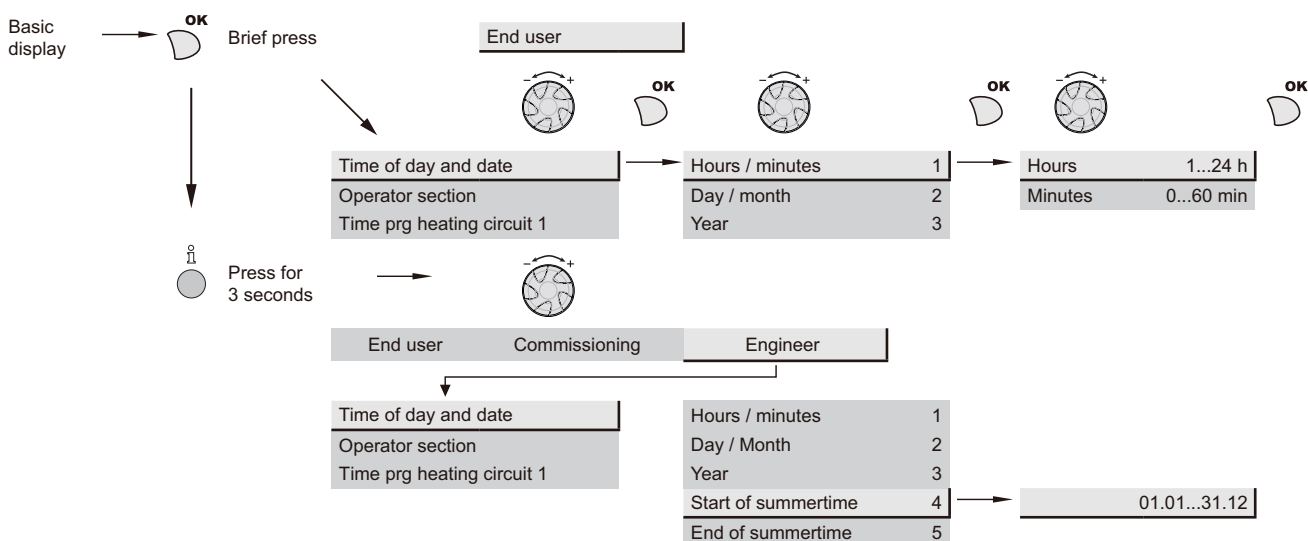

3. Function table

Description of abbreviations:

- HC: Heating circuit
- OT: Outdoor temperature
- HP: Heat pump
- DHW: Domestic hot water
- BXx, EXx, QXx, DOx, UXx, Hx: Terminal number

3-1. Time of day and date

The controller has an annual clock which contains the time, the day of the week and date. In order for the function to operate, the time and date must be set properly on the clock.

Line	Access	Function	Setting range or display	Setting increment	Factory setting
1	U	Hours/minutes	00:00...23:59	1	
2	U	Day/month	01.01...31.12	1	
3	U	Year	1900...2099	1	
5	S	Start of summer time (Day/ Month)	01.01...31.12	1	25.03
6	S	End of summer time (Day/ Month)	01.01...31.12	1	25.10

The change of hour will appear at 3:00 first Sunday after the regulated date.

NOTE: Summer time/winter time change dates have been set for changing to summer time or to winter time. The time changes automatically from 2 am (winter time) to 3 am (summer time) or from 3 am (summer time) to 2 am (winter time) on the first Sunday following the respective date.

3-2. Operator section

Line	Access	Function	Setting range or display	Factory setting
20	U	Language	English, Français, Italiano, Nederlands...	English
22	S	Info	Temporary, Permanent	Temporary
26	S	Operation lock	On, Off	Off
27	S	Programming lock	On, Off	Off
28	I	Direct adjustment	Automatic storage, With confirmation	With confirmation
29	I	Temperature units Pressure units	°C, °F bar, psi	°C bar
44	I	Operation HC2	Jointly with HC1 Independently	Jointly with HC1
46	I	Operation HC3/P	Jointly with HC1 Independently	Jointly with HC1
70	S	Display software version		

- **Info (line: 22)**

- Temporary

After pressing the Info key, the information display returns “predefined” basic display after 8 minutes or when pressing the operating mode key.

- Permanently

After pressing the Info key, the information display returns “new” basic display after a maximum of 8 minutes. The last selected information value is shown in the new basic display.

- **Operation lock (line: 26)**

If the operating lock is activated, the following control elements can no longer be adjusted: Heating circuit mode, DHW mode, room temperature comfort setpoint (knob), occupancy key.

- **Programming lock (line: 27)**

If the programming lock is activated, the setting values are displayed, but may no longer be changed.

- **Temporary suspension of programming:**

The programming lock can be temporarily deactivated at programming level. To do this, simultaneously press OK and ESC buttons for at least 3 seconds. The temporary suspension of the programming lock remains in effect until you exit the programming.

- **Permanent suspension of programming:**

First perform a temporary suspension, then cancel “Programming lock” on line 27.

- **Direct adjustment (line: 28)**

- **Storage with confirmation**

Correction of the setpoint with the knob will be adopted only after pressing OK button.

- **Automatic storage**

Correction of the setpoint with the knob is adopted without a particular confirmation (timeout) or by pressing OK button.

- **Display software version (line: 70)**

The display shows the current version of the user interface.

3-3. Time program functions

- Time program heating/cooling, circuit 1

Line	Access	Function	Setting range or display	Setting increment	Factory setting
500	U	Pre-selection (Day/Week)	Mon-Sun, Mon-Fri, Sat-Sun, Monday, Tuesday, ...		Mon-Sun
501	U	1 st phase on (start)	00:00...--:--	10 minutes	06:00
502	U	1 st phase off (end)	00:00...--:--	10 minutes	22:00
503	U	2 nd phase on (start)	00:00...--:--	10 minutes	--:--
504	U	2 nd phase off (end)	00:00...--:--	10 minutes	--:--
505	U	3 rd phase on (start)	00:00...--:--	10 minutes	--:--
506	U	3 rd phase on (end)	00:00...--:--	10 minutes	--:--
516	U	Default values, circuit 1	No, Yes		No
	Yes + OK: The default values memorized in the regular replace and cancel the customized heating programs. Your customized settings are therefore lost.				

- Time program heating/cooling, circuit 2

(Only with the 2nd circuit kit option)

Line	Access	Function	Setting range or display	Setting increment	Factory setting
520	U	Pre-selection (Day/Week)	Mon-Sun, Mon-Fri, Sat-Sun, Monday, Tuesday, ...		Mon-Sun
521	U	1 st phase on (start)	00:00...--:--	10 minutes	06:00
522	U	1 st phase off (end)	00:00...--:--	10 minutes	22:00
523	U	2 nd phase on (start)	00:00...--:--	10 minutes	--:--
524	U	2 nd phase off (end)	00:00...--:--	10 minutes	--:--
525	U	3 rd phase on (start)	00:00...--:--	10 minutes	--:--
526	U	3 rd phase off (end)	00:00...--:--	10 minutes	--:--
536	U	Default values, circuit 2	No, Yes		No
	Yes + OK: The default values memorized in the regular replace and cancel the customized heating programs. Your customized settings are therefore lost.				

- Time program 4/DHW

Line	Access	Function	Setting range or display	Setting increment	Factory setting
560	U	Pre-selection (Day/Week)	Mon-Sun, Mon-Fri, Sat-Sun, Monday, Tuesday, ...		Mon-Sun
561	U	1 st phase on (start)	00:00...--:--	10 minutes	00:00
562	U	1 st phase off (end)	00:00...--:--	10 minutes	05:00
563	U	2 nd phase on (start)	00:00...--:--	10 minutes	14:30
564	U	2 nd phase off (end)	00:00...--:--	10 minutes	17:00
565	U	3 rd phase on (start)	00:00...--:--	10 minutes	--:--
566	U	3 rd phase off (end)	00:00...--:--	10 minutes	--:--
576	U	Default values, circuit 2	No, Yes		No
	Yes + OK: The default values memorized in the regular replace and cancel the customized heating programs. Your customized settings are therefore lost.				

- **Holidays heating circuit 1**

For the holiday program is active, the heating mode should be on AUTO.

Line	Access	Function	Setting range or display	Setting increment	Factory setting
641	U	Pre-selection	Period 1...8		Period 1
642	U	Period start (Day/Week)	01.01...31.12	1	
643	U	Period end (Day/Week)	01.01...31.12	1	
648	U	Operating level	Frost protection, Reduced		Frost protection

- **Holidays heating circuit 2**

For the holiday program is active, the heating mode should be on AUTO.

If the installation consists of 2 heating circuits (Only with the 2nd circuit kit option)

Line	Access	Function	Setting range or display	Setting increment	Factory setting
651	U	Pre-selection	Period 1...8		Period 1
652	U	Period start (Day/Week)	01.01...31.12	1	
653	U	Period end (Day/Week)	01.01...31.12	1	
658	U	Operating level	Frost protection, Reduced		Frost protection

Adjustment function details:

Several control programs are available for the heating circuits and the production of DHW. They are initiated in "Automatic" mode and control the change in temperature levels (and therefore the associated setpoints, reduced and comfort) via the adjusted changeover times.

- **Changeover points**

Line				Function
HC1	HC2	4/DHW	5	
500	520	560	600	Pre-selection (Mo-Su/Mo-Fr/Sa-Su/Mo...Su)
501	521	561	601	1 st phase on
502	522	562	602	1 st phase off
503	523	563	603	2 nd phase on
504	524	564	604	2 nd phase off
505	525	565	605	3 rd phase on
506	526	566	606	3 rd phase off

- **Standard program**

All time programs can be reset to factory settings. Each time program has its own programming line for this reset action. In this case, individual settings will be lost.

Line				Function
HC1	HC2	4/DHW	5	
516	536	576	616	Default values (No, Yes)

- **Holidays**

The holiday program enables changing the heating circuits over to a selected operating level according to the date (calendar).

Line		Function
HC1	HC2	
641	651	Pre-selection
642	652	Period start (Day/Month)
643	653	Period end (Day/Month)
648	658	Operation level

- **! Important**

The holiday program can be used only in the automatic mode.

3-4. Heating circuit 1 and 2 functions

• Heating circuit 1

Line	Access	Function	Setting range or display	Setting increment	Factory setting
710	U	Comfort setpoint	Reduced setpoint...Comfort setpoint maximum	0.5°C	20°C
712	U	Reduced setpoint	Frost protection setpoint...Comfort setpoint	0.5°C	19°C
714	U	Frost protection setpoint	4 °C...Reduced setpoint	0.5°C	8°C
716	S	Comfort setpoint maximum	20...35°C	1°C	28°C
720	I	Heating curve slope	0.1... 4	0.02	0.5
721	I	Offset of the heating curve	-4.5...4.5°C	0.5°C	0°C
730	I	Summer/winter heating limitations	8...30°C	0.5°C	18°C
	When the average of the outdoor temperatures over the past 24 hours reaches 18°C, the regulator switches off the heating (as an economy measure). During summer mode, the display shows "Eco". This function is only active in automatic mode.				
740	I	Flow temperature setpoint minimum	8°C...Flow temp setpoint maximum	1°C	17°C
	(With dynamic radiator, adjust from 30 to 35°C)				
741	I	Flow temperature setpoint maximum	Flow temp setpoint minimum...70°C	1°C	60°C
	Floor heating system = 50°C/Radiator = 65°C ! Important Maximum temperature limitation is not a safety function as required by ground heating.				
750	S	Room influence	1...100%	1%	50%
760	S	Room temperature limitation	0.5...4°C	0.5°C	0.5°C
	As soon as the room temperature = [Setpoint line 710 (ex. 20°C) + Room temperature limitation setpoint line 760 (ex. 0.5°C)] > 20.5°C → The heat pump is stopped. It restarts when the room temperature falls below the setpoint. (ex. room temperature < 20.0°C)				
780	S	Quick setback	Off Down to reduced setpoint Down to frost protection setpoint		Off
790	S	Optimum start control maximum (Early start to switch to the comfort setting)	0...360 minutes	10 minutes	180 minutes
791	S	Optimum stop control maximum (Early stop to switch from the comfort setting to the reduced setting)	0...360 minutes	10 minutes	30 minutes
800	S	Reduced setpoint increase start	-30...10°C	1°C	---°C
801	S	Reduced setpoint increase end	-30...10°C	1°C	-5°C
830	S	Mixer valve boost	0...50°C	1°C	0°C
834	S	Actuator running time	30...873 seconds	1 second	240 seconds

Line	Access	Function	Setting range or display	Setting increment	Factory setting
850	I	Floor curing function			Off
	<ul style="list-style-type: none"> • Off: Early interruption of the current program, program inactive • Operational heating • Heating ready for occupation • Operational heating + ready heating • Ready heating + Operational heating • Manual: Manual mode enables you to program your own concrete slab drying time. The function ends automatically after 25 days. 				
851	I	Floor curing setpoint manually	0...95°C	1°C	25°C
	This function enables you to set the custom concrete slab drying temperature. This temperature remains fixed. The concrete slab drying program stops automatically after running for 25 days.				
856	I	Floor curing day current	0...32		
857	I	Floor curing days completed	0...32		
900	S	Operating mode changeover	None, Protection mode, Reduced, Comfort, Automatic	1	Reduced
	Operating mode at the end of concrete slab drying period.				

• Heating circuit 2

Line	Access	Function	Setting range or display	Setting increment	Factory setting
1010	U	Comfort setpoint	Reduced setpoint...Comfort setpoint maximum	0.5°C	20°C
1012	U	Reduced setpoint	Frost protection setpoint...Comfort setpoint	0.5°C	19°C
1014	U	Frost protection setpoint	4°C...Reduced setpoint	0.5°C	8°C
1016	S	Comfort setpoint maximum	Comfort temperature...35 °C	1°C	28°C
1020	I	Heating curve slope	0.1...4	0.02	0.5
1021	I	Offset of the heating curve	-4.5...4.5°C	0.5°C	0°C
1030	I	Summer/winter heating limits	8...30 °C	0.5°C	18°C
	When the average of the outdoor temperatures over the past 24 hours reaches 18°C, the regular switches off the heating (as an economy measure). During summer mode, the display shows "Eco". This function is only active in automatic mode.				
1040	I	Flow temperature setpoint minimum	8...70°C	1°C	17°C
	(With dynamic radiator, adjust from 30 to 35°C)				
1041	I	Flow temperature setpoint maximum	8...70°C	1°C	60°C
	Floor heating system = 50°C/Radiators = 65°C ! Important Maximum temperature limitation is not a safety function as required by ground heating.				
1050	S	Room influence	1...100%	1%	50%
	If the installation is fitted with a room thermostat: This function enables you to choose the ambient temperature's influence on the setting. If no value is entered, the setting is made based on the temperature control. If the parameter is set at 100%, the setting is only based on the ambient temperature.				
1060	S	Room temperature limitation	0.5...4°C	0.5°C	0.5°C
	As soon as the room temperature = [Setpoint line 1010 (ex. 20°C) + Room temperature limitation setpoint line 1060 (ex. 0.5 °C)] > 20.5 °C => The heat pump is stopped. It restarts when the room temperature falls below the setpoint (in the example, Room temperature < 20.0 °C).				
1080	S	Quick setback	Off Down to reduced setpoint Down to frost protection setpoint		Off
1090	S	Optimum start control maximum	0...360 min	10 minutes	180 minutes
1091	S	Optimum stop control maximum	0...360 min	10 minutes	30 minutes
1100	S	Reduced setpoint increase start	---, -30...10°C	1°C	---°C
1101	S	Reduced setpoint increase end	---, -30...10°C	1°C	-5°C
1130	S	Mixer valve boost	0...50°C	1°C	0°C
1134	S	Actuator running time	30...873 sec	1 second	240 seconds
1150	I	Floor curing function			Off
	<ul style="list-style-type: none"> Off: Early interruption of the current program, program inactive Operational heating Heating ready for occupation Operational heating + ready heating Ready heating + operational heating Manual: Manual mode enables you to program your own concrete slab drying time The function ends automatically after 25 days 				

Line	Access	Function	Setting range or display	Setting increment	Factory setting
1151	I	Floor curing setpoint manually (if line 1150 = manual)	0...95°C	1°C	25°C
		This function enables you to set the custom concrete slab drying temperature. This temperature remains fixed. The concrete slab-drying program stops automatically after running for 25 days.			
1156	I	Floor curing day current	0...32		
1157	I	Floor curing day completed	0...32		0
1200	S	Operating mode changeover	None, Protection mode, Reduced, Comfort, Automatic		Reduced
		Operation mode at the end of concrete slab drying period			

Adjustment function details:

• Operating mode

For heating circuits, there are several functions available which can be individually adjusted for each heating circuit. The programming lines for the 2nd heating circuit are displayed only if the extension module has been connected to the controller. Operation of heating circuits 1 and 2 is directly controlled via a operating mode key.

• Setpoint values

Line		Function
HC1	HC2	
710	1010	Comfort setpoint
712	1012	Reduced setpoint
714	1014	Frost protection setpoint
716	1016	Maximum comfort setpoint

– Room temperature:

Room temperature can be set according to different setpoint values. Depending on the selected mode, these setpoints are activated and provide different temperature levels in the rooms. The ranges of configurable setpoints are defined by their interdependencies, as shown in the graph below.

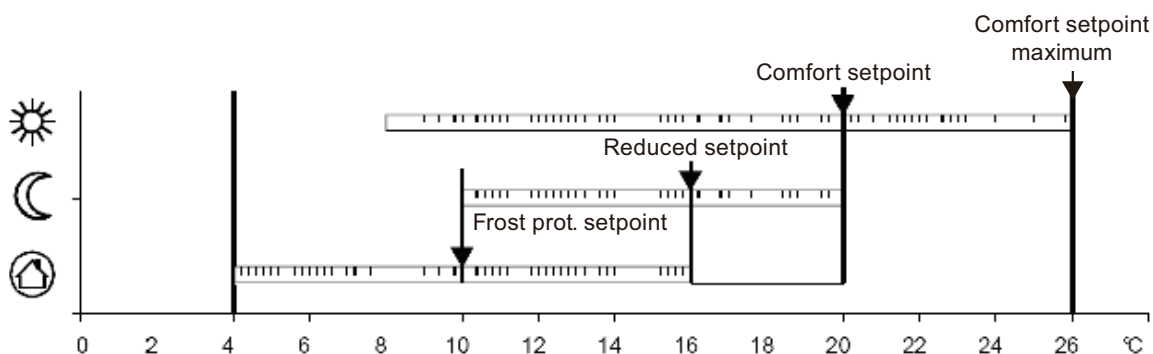

– Frost protection:

The protection mode automatically prevents an excessively sharp drop in room temperature. In this case, the control adopts the frost protection room setpoint.

• Heating curve

All time programs can be reset to factory settings. Each time program has its own programming line for this reset action. In this case, individual settings will be lost.

Line		Function
HC1	HC2	
720	1020	Heating curve slope
721	1021	Heating curve displacement

– Heating curve slope

Based on the heating characteristic, the controller computes the flow temperature setpoint which will be used for controlling the flow temperature in consideration of atmospheric conditions. Different setting can be used to adapt the heating characteristic so that the heating capacity, and therefore the room temperature, will match the individual needs. The colder outdoor temperature, the greater extent to which the slope will modify the flow temperature. In other words, the slope should be corrected if the room temperature shows a difference when the outdoor temperature is low, but not when it is high.

- Increase the setting:
The flow temperature is increased mainly when the outdoor temperatures are low.
- Decrease the setting:
The flow temperature is lowered mainly when the outdoor temperatures are low.

⚠ WARNING

The heating curve is adjusted in relation to a room temperature setpoint of 20°C. If the room temperature setpoint is modified, the flow temperature setpoint is automatically recomputed. This will not modify the setting and amounts to automatically adapting the curve.

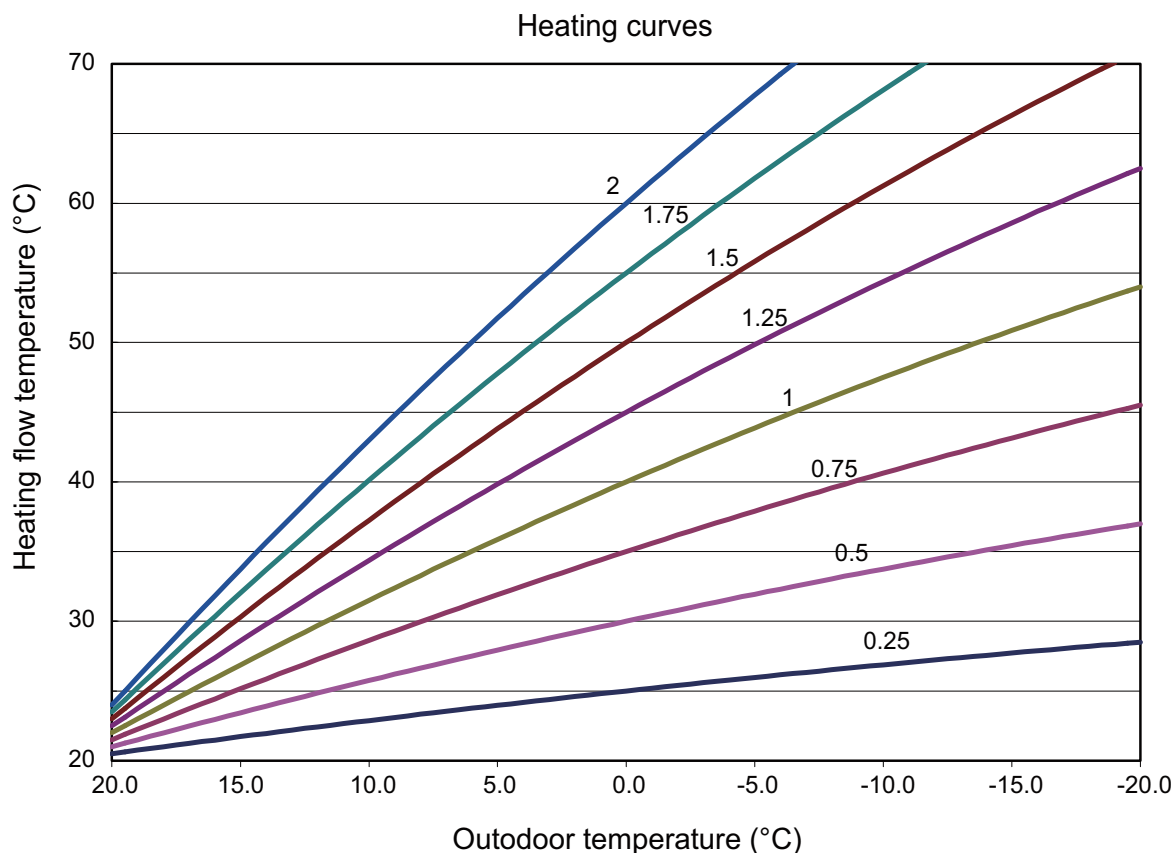

– Heating curve displacement

The curve displacement (offset) modifies the flow temperature in general and even manner over the full range of outdoor temperature. In other words, the displacement should be corrected when the room temperature is generally too high or too low.

• Eco functions

Line		Function
HC1	HC2	
730	1030	Summer/Winter heating limit

– Summer/Winter heating limit

The summer/winter heating limit switches the heating on or off through the year according to the temperature ratio. Changeover is performed automatically when in automatic mode and thus avoids the user having to turn the heating on or off. Changing the input value makes the respective annual periods (summer/winter) shorter or longer.

- If the value is increased:
Changing to winter operating mode is advanced, changing to summer mode is delayed.
- If the value is decreased:
Changing to winter mode is delayed, changing to summer mode is advanced.

! Important

This function does not work in “Continuous comfort temperature” mode (Sunlight). The controller displays “ECO”. The outdoor temperature is attenuated to take the building’s dynamics into account.

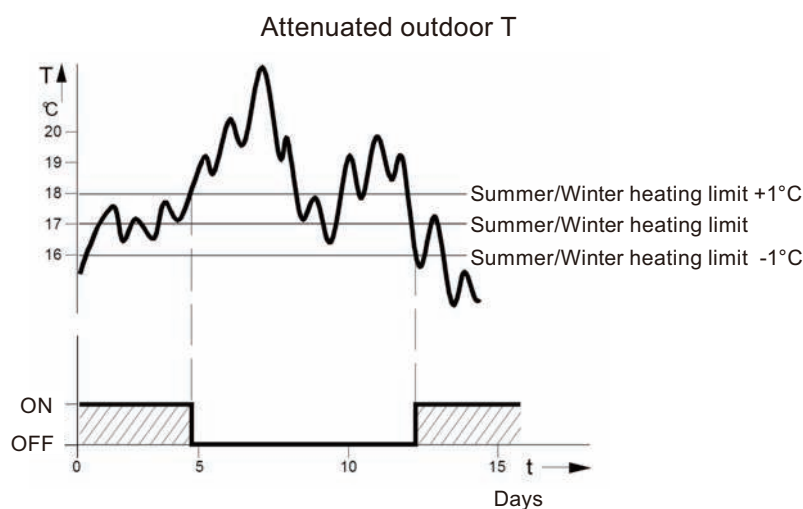

• Flow temperature setpoint

Line		Function
HC1	HC2	
740	1040	Flow temperature setpoint minimum (For fan converters)
741	1041	Flow temperature setpoint maximum

This limitation allows to define a range for the flow temperature setpoint. When flow temperature setpoint demanded by heating circuit reaches the threshold, the setpoint remains permanently at the maximum or minimum, even if the heat demand continues to increase or decrease.

Example (Line 741 and 1041):

- Flow heating system = 50°C
- Higher temperature radiator = 65°C

- **Room influence**

Line		Function
HC1	HC2	
750	1050	Room influence

- **Control types:**

When using a room temperature sensor there are 3 different types of control to choose from.

Setting	Control type
---%	Simple control according to outdoor conditions*
1...99%	Control according to outdoor conditions with room influence*
100%	Control according to room temperature only

*: Requires the connection of an outdoor sensor

- **---%: Simple control according to outdoor conditions**

The flow temperature is computed via the heating curve according to the composite outdoor temperature. This type of control requires proper adjustment of heating curve, as the control does not take the room temperature into account for this adjustment.

- **1...99%: Control according to outdoor conditions with room influence**

The difference between the room temperature and the setpoint value is measured and taken into account for temperature control. This enables taking into account possible heat inputs and ensures a more accurate room temperature control. The influence of the difference is defined as a percentage. The better the installation in the reference room (accurate room temperature, correct installation location, etc.) the higher will be the value that can be set.

Example:

- Approximate 60%: The reference room is appropriate.
- Approximate 20%: The reference room is inappropriate.

NOTE: Activation of the function requires taking into account the following requirements:

- A room sensor must be connected.
- The “room influence” parameter must be set between 1 and 99.
- The reference room (where the room sensor is installed) must not contain adjusted thermostatic valves. If present in the room, these valves must be fully open.

- **100%: Control according to room temperature only**

The flow temperature is adjusted according to the room temperature setpoint, the current room temperature and its evolution. A slight increase in room temperature, for example, causes an immediate drop in the flow temperature.

NOTE: Activation of the function requires taking into account the following requirements:

- A room sensor must be connected.
- The “room influence” parameter must be set 100.
- The reference room (where the room sensor is installed) must not contain adjusted thermostatic valves. If present in the room, these valves must be fully open.

- **Quick setback**

Line		Function
HC1	HC2	
760	1060	Room temperature limitation
780	1080	Quick setback

- **Room temperature limitation:**

The room temperature limitation function enables the heating circuit pump to be deactivated should the room temperature exceed the current room temperature setpoint by more than the adjusted differential.

The heating circuit pump is activated again as soon as the room temperature falls to a level below the current room temperature setpoint. During the time, the room temperature limitation function is active, no heat request is sent to the producer.

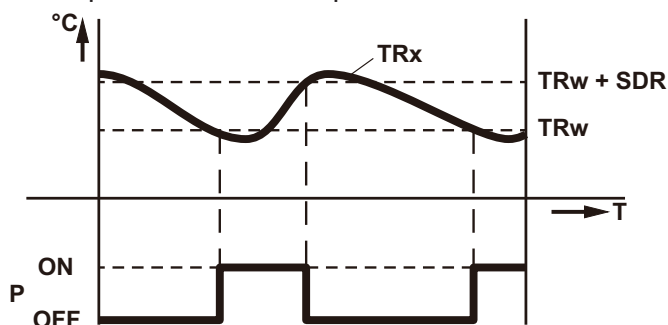

TRx: Actual value of room temperature
 TRw: Room temperature setpoint
 SDR: Room switching differential
 P: Pump
 T: Time

- **Quick setback:**

During quick setback, the heating circuit pump is deactivated and, in the case of mixing circuits, the mixing valve is fully closed.

When using a room sensor, the function keeps the heating off until the room temperature drops to the level of the “Reduced” or “Frost protection” setpoint. If the room temperature falls to the reduced or frost level, the heating circuit pump is activated and the mixing valve is released. Quick setback switches the heating off for a certain period of time, depending on the outside temperature and the building time constant.

Duration of quick setback when “Comfort” setpoint minus “Reduced” setpoint = 2 K (e.g. “Comfort” setpoint = 20 °C and “Reduced” setpoint = 18 °C)

Composite outside temperature	Building time constant: 5 h
	Duration of quick setback (h)
15°C	7.7
10°C	3.3
5°C	2.1
0°C	1.6
-5°C	1.3
-10°C	1.0
-15°C	0.9
-20°C	0.8

- **Optimization at switch-on and switch-off**

Line		Function
HC1	HC2	
790	1090	Optimum start control maximum
791	1091	Optimum stop control maximum

- **Optimum start control maximum:**

The change in temperature levels is optimized in such a way as to reach the comfort setpoint during changeover times.

- **Optimum stop control maximum:**

The change in temperature levels is optimized in such a way as to reach the comfort setpoint $-1/4$ °C during changeover times.

- **Reduced setpoint increase**

Line		Function
HC1	HC2	
800	1100	Reduced setpoint increase start
801	1101	Reduced setpoint increase end

This function is used mainly in heating installations that do not have high supplies of power (e.g. low power use homes). When outdoor temperatures are low, adjusting the temperature would take too long. Increasing the reduced setpoint prevents excessive cooling of the rooms in order to shorten the temperature adjustment period when changing over to the comfort setpoint.

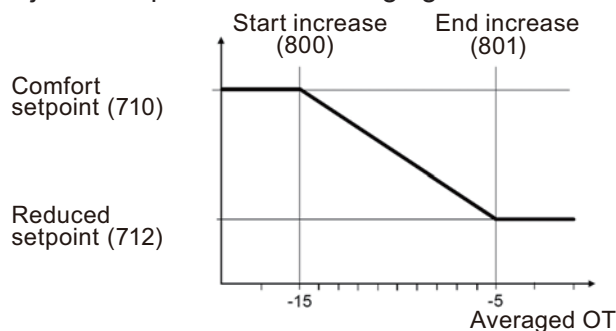

- **Mixing valve control**

Line		Function
HC1	HC2	
830	1130	Mixer valve boost
834	1134	Actuator running time

- **Mixer valve boost:**

The controller adds the increase set here to the current flow setpoint and uses the result as the temperature setpoint for the heater generator.

- **Actuator running time:**

For the 3-position servomotor, the travel time can be adjusted. With a 2-position servomotor, the adjusted travel time is inoperative.

- **Controlled floor drying function**

Line		Function
HC1	HC2	
850	1150	Floor curing function
851	1151	Floor curing setpoint manually
856	1156	Floor curing day current
857	1157	Floor curing day completed

This function is used in the controlled drying of floors. It adjusts the flow temperature to a temperature profile. Drying is performed by floor heating via the heating circuit with a mixing valve or with a pump.

- **Floor curing function:**

- **Off:** The function is deactivated.
- **Heating operational (Fh):** The first part of the temperature profile is automatically completed.
- **Heating “ready for occupation” (Bh):** The second part of the temperature profile is handled automatically.
- **Heating “ready for occupation”/Heating operational:** The full temperature profile (1st and 2nd part) is performed automatically.
- **Manual:** No temperature profile is performed, but the control is performed according to the “manual controlled drying setpoint”. The function is automatically terminated after 25 days.

- **! Important**

- The standards and directions of the building contractor must be followed.
- This function will not work properly unless the installation has been adequately made (hydraulic, electricity, settings). Otherwise, floor to be dried may be damaged.
- The function may be prematurely interrupted by setting it to Off.
- The maximum flow temperature limitation remains active.

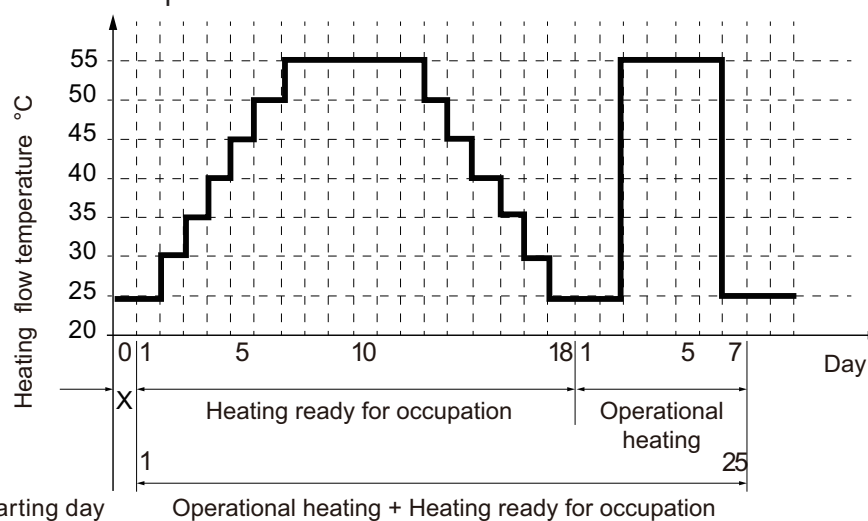

Comply with the standards and instructions of the manufacturer of the building.

A good performance of this function is only possible with an installation correctly implemented (hydraulic, electricity and adjustments).

This function can be stopped by anticipation when setting the adjustment on “Off”.

- **Floor curing setpoint manually:**

The flow temperature setpoint for the “Manual” controlled floor drying function can be adjusted respectively for each heating circuit.

- **Floor curing day current:**

Displays the current flow temperature setpoint for the controlled floor drying function.

– **Floor curing day completed:**

Displays the current day of the controlled floor drying function.

! Important

After a power outage, the installation resumes the controlled drying function as it was when the outage occurred.

• **Operating mode changeover**

Line		Function
HC1	HC2	
900	1200	Operating mode changeover

In case of an external changeover via input H2 (on the extension module only) the operating mode to which the changeover will be performed must be previously defined.

• **Heating circuit frost protection**

The heating circuit frost protection is continuously activated (protection mode ☺) and is not adjustable.

- **Heating circuit frost protection in heating mode:** If the flow temperature is below 5°C, the controller initiates the production of heat and starts the heating pump, regardless of the current heating mode. If the flow temperature rises again above 7°C, the controller waits another 5 minutes, and then stops the production of heat and the heating pumps.
- **Heating circuit frost protection in cooling mode:** Refer to cooling mode.

3-5. Cooling circuit 1 functions

Line	Access	Function	Setting range or display	Setting increment	Factory setting
901	U	Operating mode	Protection, Automatic, Reduced, Comfort		Protection
902	U	Comfort cooling setpoint	17...40°C	0.5°C	24°C
903	U	Reduced setpoint	5...40°C		26°C
908	I	Flow temperature setpoint at OT 25°C	6...35°C	0.5°C	20°C
909	I	Flow temperature setpoint at OT 35°C	6...35°C	0.5°C	16°C
912	I	Cooling limitation at OT	8...35°C	0.5°C	24°C
913	S	Lock time at end of heating/cooling	8...100 h	1 h	24 h
918	S	Summer compensation start at OT	20...50°C	1°C	26°C
919	S	Summer compensation end at OT	20...50°C	1°C	40°C
920	S	Summer compensation setpoint increase	1...10°C	1°C	4°C
923	S	Flow temperature setpoint minimum OT 25°C	6...35°C	0.5°C	18°C
924	S	Flow temperature setpoint minimum OT 35°C	6...35°C	0.5°C	18°C
928	S	Room influence	1...100%	1%	80%
	If the installation is fitted with a room thermostat: This function enables you to choose the ambient temperature's influence on the setting. If no value is entered, the setting is made based on the temperature control. If the parameter is set at 100%, the setting is only based on the ambient temperature.				
932	S	Room temperature limitation	0.5...4°C	0.5°C	0.5°C
938	S	Mixing valve decrease	0...20°C	1°C	0°C
941	S	Actuator running time	30...873 s	1 second	240 seconds
963	S	With primary controller/system pump	No, Yes		No*
	*: Basic setting: 1 circuit = No; 2 circuit = Yes				

The cooling sequence is automatically started when the room temperature is higher than the comfort setpoint in cooling mode (line 902). The cooling function must be activated (line 901 = Auto) and is triggered by programming clock (line 907). The cooling sequence is interrupted as soon as heating circuit 1 indicates a need for heat or in the presence of a heat demand signal from a DHW circuit or other heating circuit (only if cooling is active).

The controller measures the current room temperature and compares it with the room temperature setpoint to compute the flow temperature setpoint. If the temperature is not low enough the heat pump is started to provide cooling (reversed control of the mixing valve).

The following settings apply to the hydraulic circuit in zone 1 (HC1). If there is a second zone, this zone can be cooled with the setting (line 963) which will connect the pump directly to zone 2. This will require setting the "Mixing valve sub-cooling" parameter (line 938) to a suitable value in order for both zones to be adequately cooled according to the available emitters.

⚠ WARNING

Cooling mode is prohibited on all radiators, heating only floors, or any emitters not intended for this purpose.

- **Operating mode**

Line	Function
901	Operating mode (Off/Automatic)

The cooling key on the user interface enables switching between operating modes.

- **Off:** The cooling function is deactivated.
- **Automatic:** The cooling function is automatically activated by the time program (line 907), the holiday program, the occupancy key, or according to the need.

- **Comfort cooling setpoint**

Line	Function
902	Comfort cooling setpoint

In cooling mode the room temperature control follows the comfort setpoint adjusted under this setting. The cooling comfort setpoint can be displayed with a knob on the room unit. In summer the comfort setpoint is gradually increased in relation to the outdoor temperature. (For details of the setting, refer to lines 918 to 920.)

- **Release**

Line	Function
907	Release <ul style="list-style-type: none"> • 24 h/day • Heating circuit program • Time program 5

The “Release” setting determines the time program according to which cooling is released.

- **24 h/day:** Cooling is continuously activated (24 h/day).
- **Time program HC:** Cooling is activated according to the heat circuit time program.
- **Time program 5:** Cooling is released according to time program 5.

• Cooling characteristic

Line	Function
908	Flow temperature setpoint at OT 25°C
909	Flow temperature setpoint at OT 35°C

The controller computes the flow temperature required for a given composite outdoor temperature based on the cooling characteristic. This is defined by two reference points (flow temperature setpoints at 25°C and 35°C).

- **Flow temperature setpoint 25°C:** This is the cooling flow temperature required when the composite outdoor temperature is 25°C, without summer compensation.
- **Flow temperature setpoint 35°C:** This is the cooling flow temperature required when the composite outdoor temperature is 35°C, without summer compensation.

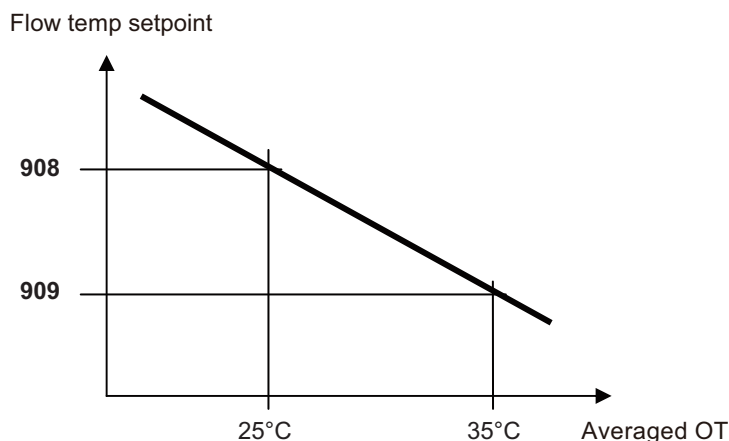

The cooling characteristic is adjusted for a 25°C room temperature setpoint. If the room temperature setpoint is changed the curve will automatically adapt.

• Eco

Line	Function
912	Cooling limitation at OT
913	Lock time at the end of heating

- **Cooling limitation at OT:** If the composite outdoor temperature is higher than the cooling limitation, cooling is released. If the composite outdoor temperature falls at least 0.5°C below the cooling limitation, cooling is locked.
- **Lock time at the end of heating:** To avoid a quick start of cooling after termination of heating, the cooling function is locked for a time period which can be adjusted with this setting. The lock time starts when there is no valid heating demand from heating circuit 1. Heating demands from heating circuit 2 or P are ignored.

NOTE: Switching off and switching on again the mode selection key causes the lock time to be interrupted.

- **Summer compensation**

Line	Function
918	Summer compensation start at OT
919	Summer compensation end at OT
920	Summer compensation setpoint increase

In summer the “cooling comfort setpoint” (line 902) is gradually increased according to the outdoor temperature. This saves on cooling power and prevents the differences between the ambient temperature of the room and the outdoor temperature being too high.

The resulting “room temperature setpoint” can be viewed in the Info section

- **Summer compensation start at OT:** Summer compensation starts to be active from the outdoor temperature defined here. If the outdoor temperature continues to rise, the comfort setpoint will be gradually increased.
- **Summer compensation end at OT:** At this outdoor temperature the summer compensation reaches its peak efficiency (line 920). If the outdoor temperature continues to rise, it will no longer influence the comfort setpoint.
- **Summer compensation setpoint increase:** This setting defines the highest value to which the comfort setpoint can be increased.

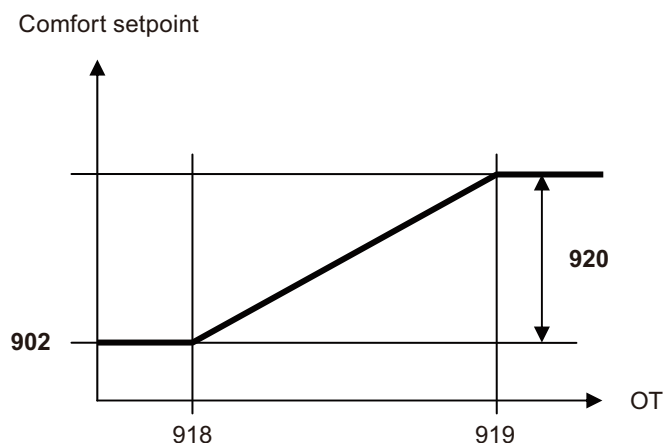

- **Flow setpoint limitation**

Line	Function
923	Flow temperature setpoint minimum at OT 25°C
924	Flow temperature setpoint minimum at OT 35°C

It is possible to assign a lower limitation to the cooling flow temperature.

The limitation line will be defined by two reference points. In addition, the resulting flow setpoint will have a lower limitation and may not be less than 5°C.

- **Flow temperature setpoint minimum at OT 25°C:** Determines the lowest flow temperature for a composite outdoor temperature of 25°C.
- **Flow temperature setpoint minimum at OT 35°C:** Determines the lowest flow temperature for a composite outdoor temperature of 35°C.

⚠ WARNING

If no outdoor temperature is available, the controller will use the “Minimum flow setpoint at OT = 35°C” parameter.

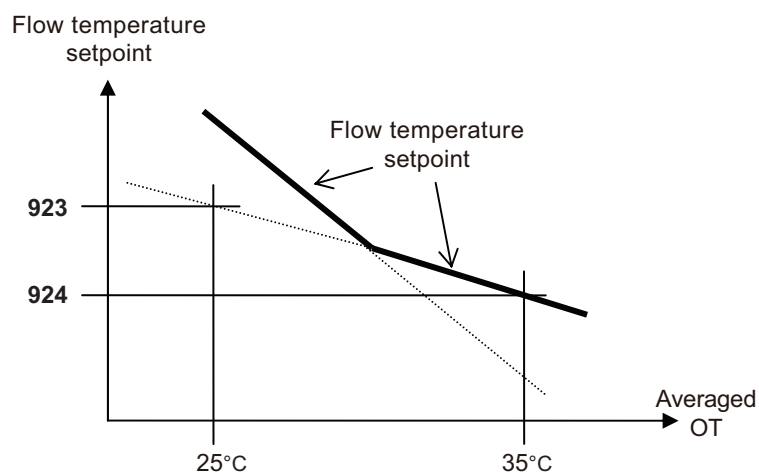

- **Room influence**

Line	Function
928	Room influence

- **Control types:**

When using a room temperature sensor there are 3 different types of control to choose from.

Setting	Control type
---%	Simple control according to outdoor conditions*
1...99%	Control according to outdoor conditions with room influence*
100%	Control according to room temperature only

*: Requires the connection of an outdoor sensor

- **---%: Simple control according to outdoor conditions**

The flow temperature is obtained from the composite outdoor temperature on the basis of the cooling characteristic. This type of control requires the cooling curve to be properly adjusted, as the control does not take the room temperature into account for this adjustment.

- **1...99%: Control according to outdoor conditions with room influence**

The difference between the room temperature and the setpoint value is measured and taken into account for temperature control. This enables taking into account possible heat inputs and ensures a more accurate room temperature control. Thus the differences with the room temperature are taken into account and the room temperature becomes more stable. The influence of the difference is defined as a percentage. The better the installation in the reference room (accurate room temperature, correct installation location, etc.) the higher will be the value that can be set.

Example:

- Approximate 60%: The reference room is appropriate.
- Approximate 20%: The reference room is inappropriate.

NOTE: Activation of the function requires taking into account the following requirements:

- A room sensor must be connected.
- The “room influence” parameter must be set between 1 and 99.
- The reference room (where the room sensor is installed) must not contain adjusted thermostatic valves. If present in the room, these values must be fully open.

- **100%: Control according to room temperature only**

The flow temperature is adjusted according to the room temperature setpoint, the current room temperature and its evolution. A slight increase in room temperature, for example, causes an immediate drop in the flow temperature.

NOTE: Activation of the function requires taking into account the following requirements:

- A room sensor must be connected.
- The “room influence” parameter must be set 100%.
- The reference room (where the room sensor is installed) must not contain adjusted thermostatic valves. If present in the room, these values must be fully open.

• Room temperature limitation setback

Line	Function
932	Room temperature limitation

The room temperature limitation function enables shutting off the cooling circuit pump if the room temperature falls below the adjusted room temperature setpoint (with summer compensation: line 920) by more than the adjusted differential.

The cooling circuit pump is reinitialized as soon as the room temperature rises again above the current room temperature setpoint. If the room temperature limitation function is active, no cooling demand will be transmitted to production.

The function is deactivated if:

- No room temperature sensor is available.
- Room influence limitation is set to “---”.
- Room influence (line 928) is set to “---% (Simple control according to outdoor conditions)”.

• Mixing valve control

Line	Function
938	Mixing valve decrease
941	Actuator running time
945	Mixing valve in heating mode

– Mixing valve decrease:

The cooling demand issued by cooling circuit 1 to production is reduced by the adjusted value. If there is a second zone, this reduction should enable the second zone to be cooled. To achieve this result, the sub-cooling must be determined in accordance with the type of emitter and “with primary controller/system pump” (line 963) must be set to “yes” to switch on the pump for the second zone.

	Configuration	How the configuration affects control
Zone 1: Heating/Cooling floor Zone 2: Fan coils	Line 938 = 10°C, with line 924 = 18°C Line 963 = yes	With a 35°C outdoor temperature, the flow setpoint will be 18°C - 10°C (i.e. 8°C). While in the first zone (HCF) it will be 18°C through action of the mixing valve.
Zone 1: Heating/Cooling floor Zone 2: HCF	Line 938 = 0°C, with line 924 = 18°C Line 963 = yes	With a 35°C outdoor temperature, the flow setpoint will be 18°C in the both zones.

⚠ WARNING

In these settings are not chosen properly, the heat pump may stop automatically due to the flow temperature being too low. A safety mechanism is triggered at 6°C to protect the exchanger from freezing.

– Actuator running time:

For the 3-position servomotor used, it is possible to adjust the travel time. With a 2-position servomotor, the adjusted travel time is inoperative.

– Mixing valve heating mode:

Determines the position of mixing valve 1 (Y1/Y2) during heating operation is activated. This parameter is inoperative in installations where heating and cooling circuits are hydraulically separate.

- **Control:** The valve controls in heating and cooling mode.
- **Open:** The valve controls in cooling, and is open in heating mode.

- **With primary controller/system pump**

Line	Function
963	With primary controller/system pump

This setting specifies whether the cooling circuit is supplied from the primary controller or from the primary pump (depending on the installation). It can also be used to provide cooling to the second zone.

⚠ WARNING

In the case of a radiator or any other emitter which does not support the cooling mode in zone 2, this setting must remain on "No".

3-6. Domestic hot water functions

Line	Access	Function	Setting range or display	Setting increment	Factory setting	
1600	U	Operating mode	Off, On, Eco		On	
1610	U	Nominal setpoint	Reduced setpoint (line 1612)...65 °C	1°C	55°C	
		The backup electrical system is required to reach this level.				
1612	U	Reduced setting	8 °C...Nominal setting (line 1610)	1°C	40°C	
1620	I	Release of DHW load	24h/day Heating circuit time program Program 4/DHW Off-peak tariff (Off-peak) Program 4/DHW and Off-peak		Program 4/DHW	
			24h/day: The temperature of the DHW is constantly maintained at the DHW comfort setting.			
			Heating circuit time program: The DHW is produced according to the programming for the ambient temperature (with 1 hour in advance when switched on).			
			Program 4/DHW: The DHW program is separate form the heating circuit program.			
			Off-peak tariff*: The electrical backup heating is only authorized to operate during the off-peak period.			
			Time program 4/DHW or low-tariff *: The electrical backup heating is authorized to operate during the comfort period or off peak.			
*: Connect the "Power Provider" contact to input EX2. In the case of a day/night contract, the electric backups for the DHW tank are subject to the power supplier's tariffs. Switching on the electric backup for the DHW tank is only authorized during off-peak hours.						
1640	I	Legionella function	Off, Periodically (depending line setting 1641), Fixed weekday (depending line setting 1642)		Off	
1641	I	Legionella function periodically	1 to 7 day	1 day	7 day	
1642	S	Legionella function weekday	Monday, Tuesday,...		Saturday	
1644	S	Legionella function time				
1645	S	Legionella function setpoint				
1646	S	Legionella function duration				
1647	S	Legionella function circuit pump	Off, On		Off	
1660	S	Legionella function weekday	Time program 3/HCP, DHW release, Time program 4/DHW, Time program 5		DHW release	

The control sets the DHW temperature, according to the time program or continuously, to the desired setpoint. The priority of DHW charging over room heating is adjustable in this case. The controller has a legionella function designed for protection against legionella in the storage tank and the pipes. The circulation pump is controlled according to the current time program and operating time.

- **Setpoint value**

Line	Function
1610	Nominal setpoint
1612	Reduced setpoint

The DHW is heated to various setpoint values. These setpoints are active according to the selected operating mode and allow the desired temperatures to be reached in the DHW storage tank.

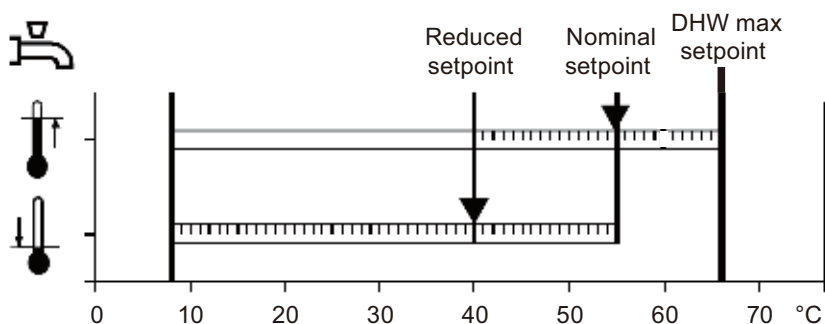

! Important

For optimal operation we recommend reducing the setpoints to the lowest value. Setpoints which are too high may interfere with heating and cause some discomfort. In this case DHW/Heating changeover cycles may successively occur. If DHW charge boosting is not desired during the day, we recommend adjusting the reduced temperature setpoint to 15°C. Full charging will occur during the night at the nominal temperature.

- Release

Line	Function
1620	Release of DHW load <ul style="list-style-type: none"> • 24h/day • Heating circuit time programs • Time program 4/DHW • Low-tariff • Time program 4/DHW or Low-tariff

The “Release” setting determines the time program according to which cooling is released.

- **24 h/day (Not recommended):** Regardless of the time programs, the temperature of the domestic hot water is continuously maintained at the DHW nominal setpoint temperature.

Example:

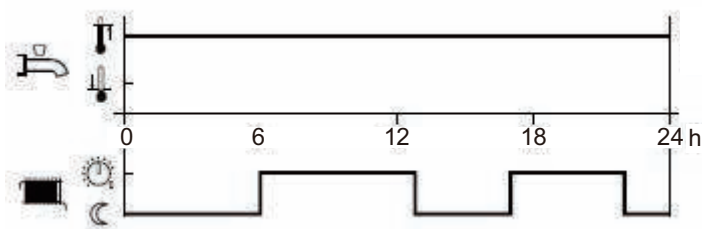

- **Heating circuit time programs (Not recommended):** Depending on the heating circuit time programs, the DHW setpoint is changed between the DHW temperature nominal setpoint and the DHW temperature reduced setpoint. The first switch-on point of each phase is advanced by one hour each time.

Example:

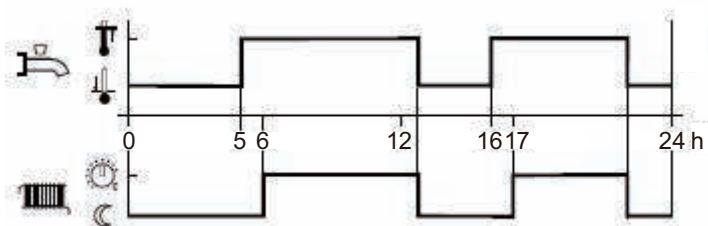

- **Time program 4/DHW (Recommended):** Time program 4 of the local controller is taken into account for the DHW mode. The changeover between DHW nominal setpoint and DHW reduced setpoint occurs on the changeover times of this program. Thus, domestic hot water charging takes place independently from the heating circuits.

Example:

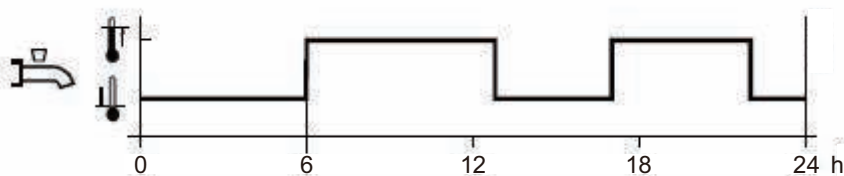

- **Low-tariff:** Released when the low-tariff input is active. (Input EX2)
- **Time program 4/DHW or Low-tariff:** Released when DHW program is set to “Nominal” or if the low-tariff input.

DHW mode	Holiday status	Release (Line 1620)	Time program status (Program 4)	Low-tariff status (EX2)	DHW mode level
Off	x	x	x	x	Frost protection
On	Yes	x	x	x	Frost protection
On	No	x	...
On	No	Low-tariff (OPK)	x	Inactive	Reduced
On	No	Low-tariff (OPK)	x	Active	Nominal
On	No	Time program 4 or OPK	Nominal	Inactive	Nominal
On	No	Time program 4 or OPK	Reduced	Inactive	Reduced
On	No	Time program 4 or OPK	Nominal	Active	Nominal
On	No	Time program 4 or OPK	Reduced	Active	Nominal

x: N/A

NOTE: Release by low-tariff input always triggers forced DHW charging. If the low-tariff input EX2 has not been configured and release via OPK has nevertheless been set, the DHW level will either continuously remain on reduced or will follow time program 4.

• Legionella function

Line	Function
1640	Legionella function
1641	Legionella function periodically
1642	Legionella function weekday

– Legionella function:

- Periodically
The legionella function occurs repeatedly according to the adjusted periodicity (line 1641).
- Fixed weekday
The legionella function can be activated on a fixed day of the week (line 1642). With this setting, heating up to the legionella setpoint occurs on the scheduled day of the week, regardless of the storage tank temperatures during the previous period.

3-7. Swimming pool functions

Line	Access	Function	Setting range or display	Factory setting
2055	U	Setpoint solar heating	8...80°C	26°C
2056	U	Setpoint source heating	8...35°C	22°C
2057	S	Switch difference source heating	0.5...3°C	0.5°C
2065	S	Charging priority solar	Priority 1, Priority 2, Priority 3	Priority 1
2080	S	Setpoint source heating	No, Yes	Yes

- **Setpoint source heating**

Line	Function
2056	Setpoint source heating

The controller enables a swimming pool to be heated by the heat pump. An individual setpoint can be set by means of line 2056, which appears when the swimming pool function is activated by parameter line 6046 being set to "Release swimming pool". Use of input H33 (X152) requires an extension module to be connected to the control.

3-8. Heat pump functions

Line	Access	Function	Setting range or display	Setting increment	Factory setting
2803	S	Overrun time condenser pump	8...240 seconds	1 second	240 seconds
2843	S	Compressor off time minimum	0...120 minutes	1 minute	8 minutes
2844	S	Switch-off temperature maximum	8...100°C	1°C	75°C
2862	S	Locking time stage 2/mod	0...40 min	1 minute	5 minutes
2873	S	Compressor mod run time	10...600 s	1 second	240 seconds
2882	S	Release integral electric flow	0...500°Cmin	1°Cmin	100°Cmin
2884	S	Flow electricity release at OT Electrical release - start-up with outside temperature	-30...30°C		2°C
2899	I	Minimum flow switch consumers	1...1,200 l/h	1 l/h	600 l/h
2916	S	Maximum setpoint HP DHW charge	8...80°C		60°C
2920	S	With electrical utility lock (EX1)	Locked (Blocked on standby), Released		Released
	Released: HP = ON _ Back-up DHW = off _ 1st back-up HP = off _ 2nd back-up HP = off _ Boiler = ON				
	Locked (Blocked on standby): HP = off _ Backup DHW = off _ 1st backup HP = off _ 2nd backup HP = off _ Boiler = ON				

- **Overrun time condenser pump**

When the compressor is switched off, the condenser pump continues to run for the set overrun time.

- **Compressor off time minimum**

For the same reason, the compressor remains switched off for the minimum period of time set here. Switch-off temperature maximum if the flow or the return temperature exceeds the maximum switch-off temperature, the compressor will be switched off. The heat pump is switched on again when the temperature at both sensors has dropped by the "Switching difference return temperature" below the maximum switch-off temperature and the minimum off time has elapsed.

- **Switch-off temperature maximum**

If the flow or the return temperature exceeds the maximum switch off temperature, the compressor will be switched off.

Example (line 2844): Floor heating system = 55°C (Higher temperature radiator = 65°C)

- **Locking time stage 2**

When compressor is restarted, the time which keeps minimum capacity can be adjusted. Efficiency become better, however the time of rising capacity becomes long.

- **Compressor mod run time**

Compressor mod run time means the time of compressor frequency indication changed from minimum to maximum. If this setting value changes to small, compressor frequency changes more quickly.

⚠ WARNING

If this setting value is too small, the efficiency is decreased due to the compressor frequency changed frequently.

- **Release integral electric flow**

After the release of the 1st stage (heater 1: on, heater 2: off), the controller compares the temperature measured with the point of engagement and forms as integral and includes a possible deficit of heat. Once the value of the integral reaches the maximum value (line 2882), the 2nd stage is engaged (heater 1: off, heater 2: control). The controller continuously compares the temperature measured at the point of engagement and new features to deficit of heat in the full release. When the full release reaches the value set (line 2882), the 3rd stage of the heater is triggered (heater 1: on, heater 2: control).

- **Flow electricity release at OT**

The heater will be activated only if the attenuated outdoor temperature is below the temperature set here.

⚠ WARNING

If this setting value is too low, there may be a feeling of discomfort due to the fact that the heat pump is unable to meet the heating requirements alone at low outdoor temperatures, and heaters are switched on.

- **Maximum setpoint HP DHW charge**

The heat pump setpoint is limited to the parameterized value during warm water charging. The function can be switched off. If the flow temperature is higher than the parameterized value, the DHW charging with heat pump will be stopped and finished with electrical immersion heater or auxiliary heat generator.

- **With electrical utility lock**

This setting relates to input EX1 (load-shedding or peak day clearing) and allows the electric heaters to be locked as follows:

- **Locked**

The heat pump and all electric heaters are locked, both heat pump stages and the DHW tank electric heater. Only the boiler backup, if installed, continues to operate.

- **Released**

The heat pump operates and all electric heaters are locked, both heat pump stages and the DHW tank electric heater. The boiler backup, if installed, continues to operate.

3-9. Energy meter

Line	Access	Function	Setting range or display	Setting increment	Factory setting
3095					
...		Not used			
3110					
3113	U	Energy brought in		Kwh	--
		Calculation of total consumed electrical energy Electrical energy consumed = Electrical energy absorbed by outdoor unit + electric energy absorbed by the heating electrical backup and/or DHW electrical backup (if installed)			
3121					
...		Not used			
3123					
3124	U	Energy brought in heating 1 (N-1)		Kwh	--
3125	U	Energy brought in DHW 1		Kwh	--
3126	U	Energy brought in cooling 1		Kwh	--
3128					
...		Not used			
3130					
3131	U	Energy brought in heating 2 (N-2)		Kwh	--
3132	U	Energy brought in DHW 2		Kwh	--
3133	U	Energy brought in cooling 2		Kwh	--
3135					
...		Not used			
3137					
3138	U	Energy brought in heating 3 (N-3)		Kwh	--
3139	U	Energy brought in DHW 3		Kwh	--
3140	U	Energy brought in cooling 3		Kwh	--
3142					
...		Not used			
3144					
3145	U	Energy brought in heating 4 (N-4)		Kwh	--
3146	U	Energy brought in DHW 4		Kwh	--
3147	U	Energy brought in cooling 4		Kwh	--
3149					
...		Not used			
3151					
3152	U	Energy brought in heating 5 (N-5)		Kwh	--
3153	U	Energy brought in DHW 5		Kwh	--
3154	U	Energy brought in cooling 5		Kwh	--
3156					
...		Not used			
3158					
3159	U	Energy brought in heating 6 (N-6)		Kwh	--
3160	U	Energy brought in DHW 6		Kwh	--
3161	U	Energy brought in cooling 6		Kwh	--
3163					
...		Not used			
3165					
3166	U	Energy brought in heating 7 (N-7)		Kwh	--
3167	U	Energy brought in DHW 7		Kwh	--
3168	U	Energy brought in cooling 7		Kwh	--
3170					
...		Not used			
3172					
3173	U	Energy brought in heating 8 (N-8)		Kwh	--

Line	Access	Function	Setting range or display	Setting increment	Factory setting
3174	U	Energy brought in DHW 8		Kwh	--
3175	U	Energy brought in cooling 8		Kwh	--
3177		Not used			
...					
3179					
3180	U	Energy brought in heating 9 (N-9)		Kwh	--
3181	U	Energy brought in DHW 9		Kwh	--
3182	U	Energy brought in cooling 9		Kwh	--
3184		Not used			
...					
3186					
3187	U	Energy brought in heating 10 (N-10)		Kwh	--
3188	U	Energy brought in DHW 10		Kwh	--
3189	U	Energy brought in cooling 10		Kwh	--
3190	S	Reset fixed day storage	No, Yes		No
	Reset the historical counters (1 to 10). The general counter (parameter 3113) is not reset.				
3197	S	Compressor electrical power	0.1...60	0.1	Refer to the table below.
3264		Not used			
...					
3267					

Factory setting for line 3197

Class	Model name	Factory setting (3197)
16.0 kW	WOYG160LJL	5.37
15.0 kW	WOYK150LJL	4.55
17.0 kW	WOYK170LJL	5.32

3-10. Additional generator (Boiler connection)

Line	Access	Function	Setting range or display	Setting increment	Factory setting
3692	S	With DHW charging	Locked		Substitute
			Substitute		
			Complement		
			Instantly		
<ul style="list-style-type: none"> DHW instantly: When DHW request, the HP and the boiler are put into operation. The HP will stop when the primary return temperature is over 55°C. DHW substitute: If the outdoor temperature is above 2°C, the operation of the HP when DHW request last 5 minutes at least. The HP operating time can be extended depending on the outdoor temperature. The boiler will active then. 					
3700	S	Release below outside temperature	-50...50°C	1°C	2°C
3701	S	Release above outside temperature	-50...50°C	1°C	---
3705	S	Overrun time	0...120 minutes	1 minute	20 minutes
3720	S	Switching integral (for boiler relief)	0...500°Cmin	1°Cmin	100°Cmin
3723	S	Locking time	1...120 minutes	1 minute	30 minutes

A supplementary producer can be operated in addition to the main producer (heat pump). Release of the supplementary producer depends on a number of parameters a detailed description of which is given on the followings.

- Release is effected via release relay Qx2
- 2-position control is effected via control relay Qx3
- Ux can be used to transmit the supplementary source a DC 0...10 V signal for the required temperature/output setpoint.

Line	Function
3692	With DHW charging

Defines the release of the supplementary source for DHW charging:

- Locked**
The supplementary source will not be released.
- Substitute**
The supplementary source is released only if the main source cannot be put into operation (e.g. in the event of fault).
- Complement**
The supplementary producer is released if the output of the main producer is not sufficient.
- Instantly**
The supplementary source will always be released.

Line	Function
3700	Release below outside temperature
3701	Release above outside temperature

Operation of supplementary source is released only when the composite outside temperature lies above or below the set temperature limitation. This enables the supplementary source to lock in a selected outside temperature range to ensure bivalent operation of supplementary source and heat pump. To ensure continuous release of the supplementary source, setting “---” must be selected on the respective operating lines. If both release values are enabled, the outside temperature must satisfy both criteria, thus ensuring release of the supplementary source.

• **Over-temperature protection**

Line	Function
3705	Overrun time

Overrun time of release for the external source: If the integral indicates another heat deficit before the overrun time has elapsed, the release remains activated. If the set overrun time elapses before the common flow temperature drops below the common flow temperature setpoint, the release is deactivated also.

• **Flow control**

Line	Function
3720	Switching integral
3723	Locking time

- **Switching integral:** The temperature-time integral is a continuous summation of the temperature differential over time. In this case, the decisive criterion is the difference by which the temperature lies above or below the common flow temperature setpoint. The temperature-time integral gives consideration not only to the period of time, but also to extent of over-/undershoot. This means that when the crossing is significant, the supplementary source is released earlier, or locked earlier, than with minor crossings.

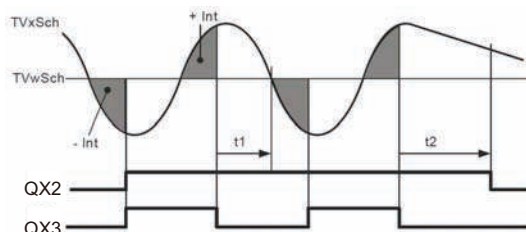

- TVx Actual value of flow temperature
- TVw Flow temperature setpoint
- + Int Surplus integral
- Int Deficit integral
- t1 Overrun time (not completed)
- t2 Overrun time (fully completed)
- QX2 Release output QX2
- QX3 Control QX3

- **Locking time:** The locking time enables the heat pump to reach a stable operating state before the supplementary source is allowed to switch on. The supplementary source is released only when the locking time has elapsed. The locking time starts as soon as a valid flow temperature setpoint is available. Calculation of the release integral starts only when the locking time has elapsed.

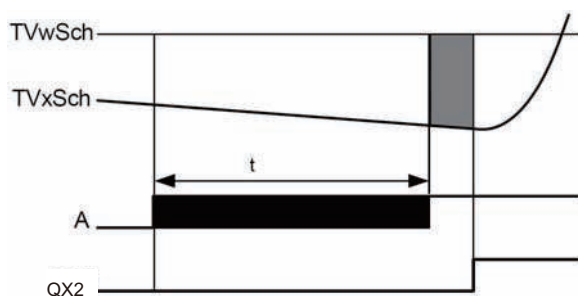

- TVxSch Actual value of common flow temperature
- TVwSch Setpoint of common flow temperature
- A Request
- QX2 Release output QX2
- T Locking time

No consideration is given to the locking time, if the heat pump malfunctions or is locked, or if the supplementary source must end DHW charging. Setting “---” can be used to deactivate the function.

3-11. DHW storage tank functions

Line	Access	Function	Setting range or display	Setting increment	Factory setting
5024	S	Switching differential	0...20°C	1°C	7°C
5030	S	Charging time limitation	10...600 minutes	10 minutes	90 minutes
(with dynamic radiator, adjust 40 minutes)					
5055	S	Re-cooling temperature	10...95°C	1°C	65°C
5057	S	Re-cooling collector	Off Summer Always		Summer
5061	S	Electric immersion heater release	24h/day Release of DHW Program 4/DHW		Release of DHW
5093	S	With solar integration	No, Yes		Yes

DHW charging at the nominal setpoint temperature (line 1610) always takes place in two stages. In the first stage, only the heat pump heats the DHW tank. The power supplied during this time is at its peak. Then, when the heat pump is no longer able to supply enough heat to reach the setpoint value, it switches on the DHW tank heater if authorized. The heater will be cut off when charging is complete. While the DHW tank charging process via the electric heater is finishing, the heat pump resume heating.

• Charging control

Line	Function
5024	Switching differential
5030	Charging time limitation

- **Switching differential:** If the DHW temperature is lower than the current setpoint minus the differential set here, the DHW charging process is launched. It ends when the temperature reaches the current setpoint.

NOTE: Forced charging is triggered on the first DHW release of the day. Charging is also launched when the DHW temperature is within the differential, and as long as it is not less than 1K above the setpoint.

- **Charging time limitation:** During charging, the room heating may be stopped or insufficient. Therefore it is often advisable to limit the charging process timewise to enable heating. If “---” has been selected the charging time limitation will be deactivated. The DHW will be heated to the nominal setpoint, even if the room heating has not received enough power in the meantime. If a value between 10 and 600 is selected, charging will be suspended after the time period set in minutes, and will remain suspended over that time before resuming. The generator power remains available in the meantime to heat the room. This cycle is repeated until the DHW nominal setpoint has been reached.

NOTE: When the room heating is stopped (summer mode, economy function, etc.), DHW charging remains active, regardless of the setting.

• Re-cooling

Line	Function
5055	Re-cooling temperature
5057	Re-cooling collector

- **Re-cooling temperature:** An activated re-cooling function remains in operation until the set re-cooling temperature in the DHW storage tank is reached.
- **Re-cooling collector:** When the collector is cold, surplus energy can be emitted to the environment via the collector's surface.

- Heater

Line	Function
5061	Electric immersion heater release

- Electric immersion heater release:

- 24 h/day

The heater is continuously active regardless of time programs.

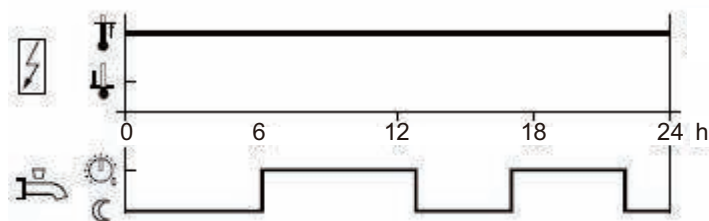

- DHW release

The heater is controlled according to DHW release.

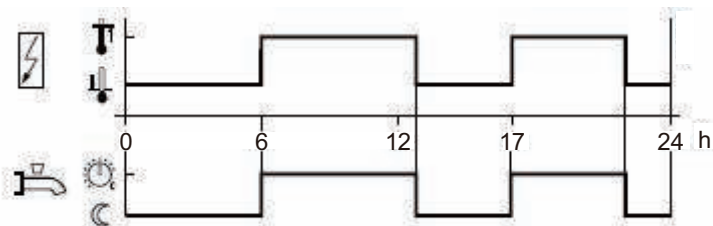

- Time program 4/DHW

Time program 4/DHW of the local controller is taken into account for the heater.

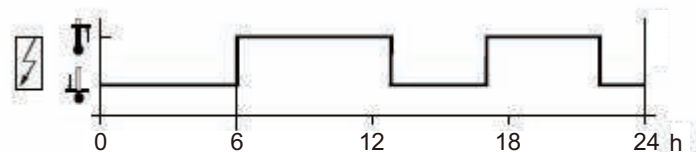

NOTE: Switch-on will actually be in effect only if the heater is able to operate according to the heater operating mode setting.

3-12. Installation configuration functions

Line	Access	Function	Setting range or display	Setting increment	Factory setting
5700	I	Pre-setting	1,2,3,... 9	1	1
	<p>This control enables you to choose one of the 4 pre-selected installation configurations. The hydraulic layouts for the various configurations are detailed in the section: "Installation Configurations".</p> <ul style="list-style-type: none"> Pre-setting 1: 1 heating circuit with or without electrical back-up, with DHW tank Pre-setting 2: 2 heating circuits with or without electrical back-up, with DHW tank Pre-setting 3: Boiler connection and 1 heating circuit and DHW tank Pre-setting 4: Boiler connection and 2 heating circuits and DHW tank Pre-setting 5 and more: Not used 				
5710	S	Heating circuit 1	Off, On		On
5711	S	Cooling circuit 1	Off		Off
			4-pipe system 2-pipe system		
Set the parameter to "2-pipe system cooling" with the cooling kit.					
5715	S	Heating circuit 2	Off, On		On
5716	S	Cooling circuit 2	Off		Off
			4-pipe system cooling 2-pipe system cooling		
Set the parameter to "2-pipe system cooling" with the cooling kit. If the installation consists of 2 heating circuits.					
5731	S	DHW controlling element Q3	No charging request Charging pump Diverting valve		Diverting valve
5740	S	Output electrical immersion heater K6	0.1...99 kW		2
5806	I	Type electrical immersion heater flow	1: 3-stage 2: 2-stage excluding 3: 2-stage complementary 4: Modulating UX		3: 2-stage complementary
5811	S	Output electrical immersion heater K25	0.1...99		3
5813	S	Output electrical immersion heater K26	0.1...99		3
5950	S	Function input H1 (Connector X86, terminals B2&M)			---
5953	S	Input value 1 H1			0
5954	S	Function value 1 H1			0
5955	S	Input value 2 H1			10
5956	S	Function value 2 H1			100

Line	Access	Function	Setting range or display	Setting increment	Factory setting
5960	S	Function input H3			None
	0: None, 1: Op'mode change zones + DHW, 2: Optg mode changeover DHW, 3: Op'mode changeover zones, 4: Op'mode changeover zone 1, 5: Op'mode changeover zone 2, 6: Op'mode changeover zone 3, 8: Error/alarm message, 9: Consumer request VK1, 10: Consumer request VK2, 11: Release swi pool source heat, 13: Release swi pool solar, 14: Operating level DHW, 15: Operating level HC1, 16: Operating level HC2, 17: Operating level HC3, 18: Room thermostat HC1, 19: Room thermostat HC2, 20: Room thermostat HC3, 21: DHW flow switch, 24: Pulse count, 26: Dewpoint monitor, 27: Flow temp setp incr hygro, 30: Swi-on command HP stage 1, 35: Status info suppl source, 36: Charg prio DHW sol fuel boil, 43: Ventilation switch 1, 44: Ventilation switch 2, 45: Ventilation switch 3, 50: Flow measurement Hz, 51: Consumer request VK1 10 V, 52: Consumer request VK2 10 V, 54: Pressure measurement 10 V, 55: Humidity measurement 10 V, 56: Room temp 10 V, 59: Flow measurement 10 V, 60: Temp measurement 10 V, 61: Air quality measurement 10 V				
5963	S	Input value 1 H3			0
5964	S	Function value 1 H3			0
5965	S	Input value 2 H3			10
5966	S	Function value 2 H3			100
5980	S	Function input EX1			1
	0: None, 1: Electrical utility lock E6, 2: Low-tariff E5, 4: Overload source E14, 5: Pressure switch source E26, 6: Flow switch source E15, 7: Flow switch consumers E24, 8: Manual defrost E17, 9: Common fault HP E20, 10: Fault soft starter E25, 12: Low-pressure switch E9, 13: High-pressure switch E10, 14: Overload compressor 1 E11, 15: Error/alarm message, 16: Mains supervision E21, 18: Pressure diff defrost E28, 19: Pres sw source int circ E29, 20: Flow sw source int circ E30, 21: Smart grid E61, 22: Smart grid E62, 25: Optg mode change HCs, 26: DHW push				
5981	S	Contact type input EX1	NC (Normally-closed contact) NO (Normally-opened contact)		NO
5982	S	Function input EX2			Low-tariff E5
	0: None, 1: Electrical utility lock E6, 2: Low-tariff E5, 4: Overload source E14, 5: Pressure switch source E26, 6: Flow switch source E15, 7: Flow switch consumers E24, 8: Manual defrost E17, 9: Common fault HP E20, 10: Fault soft starter E25, 12: Low-pressure switch E9, 13: High-pressure switch E10, 14: Overload compressor 1 E11, 15: Error/alarm message, 16: Mains supervision E21, 18: Pressure diff defrost E28, 19: Pres sw source int circ E29, 20: Flow sw source int circ E30, 21: Smart grid E61, 22: Smart grid E62, 25: Optg mode change HCs, 26: DHW push				
5983	S	Contact type input EX2	NC (Normally-closed contact) NO (Normally-opened contact)		NC
5985	S	Contact type input EX3	NC (Normally-closed contact) NO (Normally-opened contact)		NO
6098	S	Readjustment collector sensor	-20...20°C		0°C
6100	S	Readjustment outside sensor	-3...3°C	0.1°C	0°C
6117	S	Central setpoint compensation	1...100°C		5°C
6120	S	Frost protection plant	On, Off		On
6201	S	Reset sensors	No, Yes		No
6205	S	Reset to default parameters	No, Yes		No
6220	S	Software version (RVS)	0...99		---
6300	S	Info 1 OEM	0...65535		---
6301	S	Info 2 OEM	0...65535		---

When an installation is started up, the hydraulic indoor unit diagram pre-setting for that installation must be entered.

- **Pre-settings**

Line	Function
5700	Pre-setting

Only pre-setting 1 to 4 are used among 9 availables.

- **Heating circuit/Cooling circuit**

Line	Function
5710	Heating circuit 1
5711	Cooling circuit 1 <ul style="list-style-type: none"> • Off • 4-pipe system • 2-pipe system
5715	Heating circuit 2

- **Heating circuit 1:** Using this setting, heating circuit 1 can be switched on and off.
- **Cooling circuit 1:**
 - **Off**
The cooling circuit is deactivated.
 - **4-pipe system**
Not compatible with this system. This setting relates to passive cooling.
 - **2-pipe system**
Activates the heat pump cooling mode. However, the cooling kit must have been previously connected.

⚠ WARNING

If the cooling kit has not been connected and the cooling mode is activated the heat pump will behave abnormally and might cause some unwanted discomfort.

NOTE: Switching on the cooling mode causes the menu “Cooling circuit 1” to appear.

- **Heating circuit 2:** Using this setting, heating circuit 2 can be switched on and off.

- **DHW**

Line	Function
5731	DHW controlling element Q3

- **No charging request:**
No DHW charging via Q3
- **Charging pump:**
DHW charging is effected with a pump connected to terminal Q3.
- **Diverting valve:**
DHW charging is effected with a diverting valve connected to terminal Q3.

- **Electric immersion heater**

Line	Function
5806	Type electric immersion heater flow

Within the type of electric backup, 4 settings are possible:

- **3-stage:**
Not used
- **2-stage excluding:**
Not used
- **2-stage complementary:**
The backup 1 starts alone, then the backup 2 starts alone, then the two backups starts simultaneously. Example for a 3 kW backup and a 6 kW backup, 1st stage: 3 kW, 2nd stage: 6 kW, 3rd stage: 3 + 6 = 9 kW.
- **Modulating Ux:**
The backup 1 is regulated as required.

- **Basic unit EX/E**

Line	Function
5981	Contact type input EX1
5983	Contact type input EX2
5985	Contact type input EX3

The type of contact can be selected as follows:

- **NC:**
The input's function is active when voltage is not present.
- **NO:**
The input's function is active when voltage is present. The descriptions relating to the functions of the EX contact apply when an NO contact is selected.

- **Sensor corrections**

Line	Function
6098	Not used
6100	Readjustment outside sensor

The outdoor temperature measuring value can be corrected within a range of ± 3 K.

- **Installation frost protection**

Line	Function
6120	Frost protection for the plant

According to the outdoor temperature, the heating circuit pump and the condenser pump are switched on although there is no demand for heat.

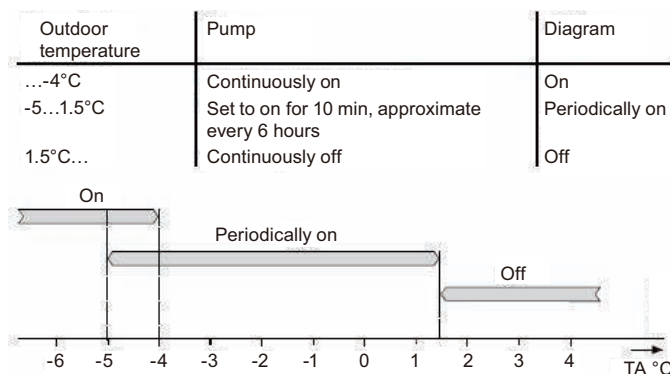

- **Miscellaneous**

Line	Function
6205	Reset to default parameters
6220	Software version

- **Reset to default parameters:**

All parameters can be reset to factory settings, except followings: Time and date, User interface, and all time programs, as well as the operating hours and the various counters.

- **Software version:**

The software version represents the controller software status at the time when the unit is being produced. It is printed on the back of the unit. The first two digits represent the software version, and the third is the revision number (e.g. 01.0).

3-13. LPB system

Line	Access	Function	Setting range or display	Factory setting
6600	S	Device address	0...16	1

3-14. Error functions

Line	Access	Function	Setting range or display	Factory setting
6710	U	Reset default relays	No, Yes	No
6711	U	Reset HP	No, Yes	No
6800	S	History 1	Time, Date, Error code	
6802	S	History 2	Time, Date, Error code	
6804	S	History 3	Time, Date, Error code	
6806	S	History 4	Time, Date, Error code	
6808	S	History 5	Time, Date, Error code	
6810	S	History 6	Time, Date, Error code	
6812	S	History 7	Time, Date, Error code	
6814	S	History 8	Time, Date, Error code	
6816	S	History 9	Time, Date, Error code	
6818	S	History 10	Time, Date, Error code	

When a fault occurs, the symbol \triangle appears and it is possible to display an error message in the Info section by pressing the Info key. The display shows what caused the fault.

- **Reset (unlock) heat pump**

Line	Function
6711	Reset HP

This line is used to clear the heat pump error messages. The predetermined switch-on delay in case of a failure is therefore ignored, which avoids waiting periods during servicing/troubleshooting. This option should not be used in normal operating conditions.

- **Error history**

Line	Function
6800 to 6818	Time stamp and history of faults 1 to 10

The controller saves the last 10 faults which have occurred to a non volatile memory. Any new entry will delete the oldest entry from the memory. A fault code and a time are saved for each fault.

Error code list:

- Designation of error:
The error designations in the table below are displayed in plain text on the user interface.
- Location:
The sensor or contact associated to the error message.
- Reset:
Reset is either automatic or manual, depending on the type of error. (For error message, refer to the table below.)
 - Manual reset:
Errors which are displayed in the Info section and accompanied by the Reset question can be manually reset. Press the OK key once, “yes” flashes on the display. Press the OK key again to confirm the “yes” and the error will be reset.
 - Automatic reset:
Automatic cleaning occurs after a previously set time (OEM setting) has elapsed. After this time out (6 hours by default) has elapsed, the controller will attempt to reset the error. If “Number” appears in the table, it is possible to define the how many times the fault can be reset before the heat pump is declared out of order.
- Heat pump operation:
Shows whether or not the heat pump can continue to operate when the error occurs.
 - Yes:
The heat pump continues to operate despite the error message.
 - No:
The error interrupts operation of the heat pump.
 - No with glycol water:
The error stops glycol water heat pumps, but does not prevent operation of water or air heat pumps.
 - No with water:
The error stops water heat pumps, but does not prevent operation of glycol water heat pumps.
 - No with air:
The error stops air heat pumps, but does not prevent operation of water heat pumps or glycol water heat pumps.
 - Per diagrams:
The heat pump will be stopped according to the current installation diagram.
 - Alarm messages
Errors are ranked by priority. From priority 5 onward (i.e. priority levels 5 to 9) the alarm messages used in remote controller are sent. In addition, the alarm relay is switched on.

Table of error messages which can be displayed:

No: Designation of error	Location	Reset		HP operation
		Manual	Automatic	
0: No fault				
10: Outdoor sensor	BX4 (X84)	No	No	Yes
30: Flow sensor 1	BX1 (X80)	No	No	Yes
31: Cooling flow sensor 1	BX1 (X80)	No	No	Yes
32: Flow sensor 2	BX31 (X153)	No	No	Yes
33: Heat pump flow temperature sensor error	BX1 (X80)	No	No	Yes
44: Heat pump return temperature sensor error	BX2 (X80)	No	No	Per diagram
50: DHW temperature sensor 1	BX3 (X84)	No	No	Yes
60: Room sensor 1		No	No	Yes
65: Room sensor 2		No	No	Yes
76: Special sensor 1	BX	No	No	Yes
83: BSB wire short-circuit		No	No	Yes
84: BSB, address collision		No	No	Yes
85: Radio communication error		No	No	Yes
98: Extension module 1		No	No	Yes
99: Extension module 2		No	No	Yes
100: 2 master clocks on bus		No	No	Yes
102: Clock without running supply		No	No	Yes
105: Maintenance message		No	No	Yes
121: HC1 flow temperature too low		No	No	Yes
122: HC2 flow temperature too low		No	No	Yes
126: DHW charge monitoring		No	No	Yes
127: Anti-legionella temperature		No	No	Yes
134: Heat pump alarm summary	E20	Yes	Number*	No
138: No heat pump control sensor		No	Yes	No
146: Sensor/Control device configuration		No	No	Yes
171: Alarm contact 1 activated	H1/H31	No	No	Yes
172: Alarm contact 2 activated	H21/H22/H32	No	No	Yes
174: Alarm contact 4 active H3		No	No	Yes
178: HC1 safety thermostat		No	No	Yes
179: HC2 safety thermostat		No	No	Yes
201: Frost alarm	BX1 (X80)	Yes	No	No
243: Swimming pool sensor	BX34 (X154)	No	No	Yes
325: BX/Ext unit: same sensors		No	No	Yes
327: Ext modules: same functions		No	No	Yes
329: Ext modules/Mixing group: same functions		No	No	Yes
330: BX1 no function		No	No	Yes
331: BX2 no function		No	No	Yes
332: BX3 no function		No	No	Yes
333: BX4 no function		No	No	Yes
334: BX5 no function		No	No	Yes
335: BX21 no function		No	No	Yes
336: BX22 no function		No	No	Yes
357: Cooling circuit flow temperature not reached		No	No	Yes
359: No cooling valve Y21		No	No	Yes
360: No process reversing valve Y22		No	No	Yes
364: Heat pump cooling system error		No	No	Yes
369: External fault				No
370: Outdoor unit fault				No

*: If such statuses or events occur for the first time, they will not directly generate a fault message, but only a status message. Only if the anomaly occurs repeatedly over a predefined time period and at a given frequency (number), an error message will be generated.

3-15. Service/Special operation functions

Line	Access	Function	Setting range or display	Setting increment	Factory setting
7070	S	HP interval	---, 1...240 months	1 month	---
7071	S	HP time since maintenance Reset? (no, yes)	0...240 months	1 month	0
7073	S	Cur starts compressor 1/hrs run Reset? (no, yes)	0...12		0
7141	U	Emergency operation	Off, On		Off
	Off: Heat pump functions normally (with boosters if necessary) On: Heat pump uses the electric boost system or the boiler connection Use the "On" position only in assist mode or test mode: may result in high power bills				
7142	S	Emergency operating function type	Manual, Automatic		Manual
	Manual: Emergency mode is not active when a fault occurs (Emergency mode = OFF) Automatic: Emergency mode is active when a fault occurs (Emergency mode = ON) In "Automatic" position, the energy cost can be onerous if the error is not detected and eliminated				
7150	I	Simulation outside temperature	-50...50 °C		---

• Maintenance

Maintenance functions can be used as a preventive step for periodically monitoring the installation. All maintenance functions can be individually activated or deactivated. The controller automatically generates maintenance messages if the settings defined are either exceeded or fail to be reached.

Line	Function
7070	HP interval
7071	HP time since maintenance
7073	Cur starts compressor 1/hrs run

- **HP interval:** Defines the maintenance frequency (in months) for the heat pump.
- **HP time since maintenance:** Displays the time (in months) elapsed since the last maintenance. If the value exceeds the "Heat pump interval" (line 7070), the symbol ⚡ will be displayed and a maintenance message will appear in the Info section:

17: Heat pump maintenance Interval (Priority 6)

This setting can be reset with the associated rights of access.

- **Cur starts compressor 1/hrs run:** The average number of compressor startups per hour of operation, obtained over a period of 6 weeks. If the value exceeds the "Compressor 1 maximum startups/hr op" adjusted setting, the symbol ⚡ will be displayed and a maintenance message will appear in the Info section:

8: Too many compressor 1 startups (Priority 9)

This setting can be reset with the associated rights of access.

- **Emergency mode**

If the heat pump is not operating properly, an emergency operation can be maintained. The emergency operation enables the installation to be run with the available heaters (flow, DHW tank). In this case, the compressor will remain off.

Line	Function
7141	Emergency operation
7142	Emergency operation function type

– **Emergency operation:** Emergency operation can be activated and deactivated manually.

- Off
Emergency operation is deactivated.
- On
Emergency operation is activated.

– **Emergency operation function type:**

- Manually
Emergency operation can be activated/deactivated only through the emergency operation setting on line 7141.
- Automatic
As soon as a fault occurs on the heat pump, emergency operation is automatically switched on. It stops when the fault is removed, and if necessary, cleared (reset). Emergency operation may however be activated/deactivated manually via the emergency operation setting on line 7141.

- **Simulation**

Line	Function
7150	Simulation outside temperature

– **Simulation outside temperature:** To make the starting-up and troubleshooting processes easier, it is possible to simulate an outdoor temperature in the range of -50...+50 °C. During simulation, the current, composite, and attenuated outdoor temperatures are ignored and substituted with the adjusted simulation temperature. Computation of the 3 outdoor temperatures based on the actual outdoor temperature continues to be performed during the simulation, and these temperatures are available again when the simulation is over.

This function can be deactivated by selecting -- on this line or automatically, after a 5 hours waiting period.

3-16. Input/Output test functions

Line	Access	Function	Setting range or display	Setting increment	Factory setting
7700	I	Relay test			No test
	<p>This consists of instructing the regulator's relays one by one and checking their outputs. This enables you to check that the relays are working and that the cabling is correct. Check that each appliance in the installation is operating correctly.</p> <p>0: No test, 1: Everything is on STOP, 2: Relay output QX1 : heat pump CC1 (if 1 circuit) or heat pump CC2 (if 2 circuits), 3: Relay output QX2 : Electrical back-up (1st stage) or Boiler connection distribution valve, 4: Relay output QX3 : Electrical back-up (2nd stage) or Boiler connection contact, 5: Relay output QX4 : DHW distribution valve, 6: Relay output QX5 : DHW Electrical back-up, 7: Relay output QX6 , 8: Relay output QX31 : Heat circ mix valve open Y1 (or control pilot-wire), 9: Relay output QX32 : Heat circ mix valve close Y2, 10: Relay output QX33 : heat pump CC1 if 2 circuits (mixed circuit, the less hot), 11: Relay output QX34, 12: Relay output QX35 : Swimming pool distribution valve, 13: Relay output QX21 module 1, 14: Relay output QX22 module 1, 15: Relay output QX23 module 1, 16: Relay output QX21 module 2, 17: Relay output QX22 module 2, 18: Relay output QX23 module 2, 19: Not used, 20: Not used, 21: Not used</p> <p>The display shows the "Key" symbol. Pressing the Info button displays "Error 368".</p> <p>⚠ WARNING</p> <p>The component being tested is receiving electrical power throughout the test.</p>				
7710	I	Output UX1 test	0...100%	1	---
7716	I	Output UX2 test	0...100%	1	---
7722	I	Digital output DO2	Off, On		Off
7723	I	Heat pump D3	Off, On		Off
7724	I	Outputs test UX3 ("Inverter" command)	0...100%		---
7725	I	Voltage value (UX3)	0...10 V		---
7804	I	Sensor temperature BX1 (HP flow temperature)	-28...350°C		---
7805	I	Sensor temperature BX2 (HP return temperature)	-28...350°C		---
7806	I	Sensor temperature BX3 (DHW temperature)	-28...350°C		---
7807	I	Sensor temperature BX4 (Outside temperature)	-28...350°C		---
7858	I	Input signal H3	None, Closed (ooo) Open (---) Pulse Frequency Hz Voltage V		None
7911	I	Input EX1 (Power shedding, EJP)	0, 230 V		---
7912	I	Input EX2 (Tariffs day/night)	0, 230 V		---
7913	I	Input EX3 (External fault)	0, 230 V		---

Input/Output testing is used to ensure that the connected components are in working order.

• Relay output testing

Selection of a setting from relay testing closes the corresponding relay and therefore switches on the connected component. This makes it possible to check that the relays are in working order and that the wiring has been performed correctly.

Line	Function
7700	Relay test

This consists of instructing the regulator's relays one by one and checking their outputs. This enables you to check that the relays are working and that the cabling is correct. Check that each appliance in the installation is operating correctly.

0: No test	11: Relay output QX34
1: Everything is on STOP	12: Relay output QX35: Swimming pool distribution valve
2: Relay output QX1: Heat pump CC1 (Main regulation board)	13: Relay output QX21 module 1
3: Relay output QX2: Electrical backup (1 st stage) or Boiler connection distribution valve	14: Relay output QX22 module 1
4: Relay output QX3: Electrical backup (2 nd stage) or Boiler connection contact	15: Relay output QX23 module 1
5: Relay output QX4: DHW distribution valve	16: Relay output QX21 module 2
6: Relay output QX5: DHW electrical backup	17: Relay output QX22 module 2
7: Relay output QX6	18: Relay output QX23 module 2
8: Relay output QX31: Heating circuit mix valve open Y1	19: Not used
9: Relay output QX32: Heating circuit mix valve close Y2	20: Not used
10: Relay output QX33: Heat pump CC2	21: Not used

The display shows the "Key" symbol. Pressing the Info key displays "Error 368".

⚠ WARNING

- The component being tested is receiving electr.
- During testing of an output, the heat pump is stopped, all outputs are "off" and only the controlled output is on.

• Analog input/output testing

Line	Function
7710	Output test UX1
7712	PWM signal UX1
7722	Cooling mode DO2
7723	Heat pump D3
7724	Output test UX3
7725	Voltage value UX3

- **Cooling mode DO2:** Shows the output status.
- **Output test UX3:** Enables testing the outdoor unit control.

- **Sensor input testing**

Displays the temperature of each sensor.

Line	Function
7820	Sensor temperature BX1
7821	Sensor temperature BX2
7822	Sensor temperature BX3
7823	Sensor temperature BX4

- **Input test EX1—3**

Line	Function
7911	Input EX1
7912	Input EX2
7913	Input EX3

By selecting a setting from input test EX1 to 3, the relevant input will be displayed, enabling it to be checked. Display of 0 V means that there is no voltage and the respective input is currently inactive. Display of 230 V means that voltage is present at respective input so that it is activated.

- **Input/Output test I/O module**

Line	Function
7973	Setting temperature BX31
7976	Setting temperature BX34
7996	Contact state H33

The sensor test operate the same as for BX1 to 4 on the basic unit.

3-17. State functions

Line	Access	Function	Setting range or display	Factory setting
8000	I	State heating circuit 1		---
8001	I	State heating circuit 2		---
8003	I	State DHW		---
8004	I	State cooling circuit 1		---
8006	I	State heat pump		---
8007	I	Not used		---
8010	I	Not used		---
8011	I	State swimming pool		---
8022	I	State supplementary source		---
8025	I	State cooling circuit 2		---

The current operating status of the installation can be reviewed by means of status displays.

• State heating circuit

End use (Info level)	Commissioning, Engineer
Thermostat response	Thermostat response
Manual action active	Manual action active
Controlled drying active	Controlled drying active
Heating mode restriction	Overeating protection active Restriction, boiler protection Restriction, DHW priority Restriction, storage tank
Forced draft	Forced draft, storage tank Forced draft, DHW Forced draft generator Forced draft Switch-off delay active
Comfort heating mode	Optimization at switch-on + accelerated heating Optimization at switch-on Accelerated heating Comfort heating mode
Reduced heating mode	Optimization at switch-off Reduced heating mode
Frost protection active	Room frost protection Flow frost protection active Installation frost protection active
Summer mode	Summer mode
Off	Eco day active Reduced decrease Frost protection decrease Room temperature limitation Off

- State DHW (8003)

End use (Info level)	Commissioning, Engineer
Thermostat response	Thermostat response
Manual action active	Manual action active
Draw-off mode	Draw-off mode
Adiabatic cooling active	Adiabatic cooling by collector Adiabatic cooling via gen/HC
Charging lock active	Discharge protection active Charging duration limitation active Charging locked
Forced charging active	Forcing, DHW tank maximum temperature Forcing, maximum charging temperature Forcing, anti-legionella setpoint Forcing, comfort setpoint
Charging by heater	Charging by heater, anti-legionella setpoint Charging by heater, comfort setpoint Charging by heater, reduced setpoint Charging by heater, frost protection setpoint Heater released
Accelerated charging active	Flow active Anti-legionella accelerated charging
Charging active	Charging, anti-legionella setpoint Charging, comfort setpoint Charging, reduced setpoint
Frost protection active	Frost protection active
Switch-off delay active	Switch-off delay active
Charging on standby	Charging on standby
Charged	Charged, maximum tank temperature Charged, maximum charging temperature Charged, anti-legionella temperature Charged, nominal temperature Charged, reduced temperature
Off	Off
Ready	Ready

- **State cooling circuit 1 (8004)**

End use (Info level)	Commissioning, Engineer
Dew point sensor activated	Dew point sensor activated
Manual action active	Manual action active
Fault	Fault
Frost protection active	Flow frost protection active
Cooling mode locked	Locked, heating mode Lock time after heating Locked, generator Locked, storage tank
Cooling mode restricted	Flow temp setpoint increase by hygrostat Dew point flow minimum limitation Outdoor temperature flow minimum limitation
Comfort cooling mode	Comfort cooling mode Switch-off delay active
Cooling protection mode	Cooling protection mode
Frost protection active	Frost protection active
OT cooling limitation activated	OT cooling limitation activated
Off	Off Room temperature limitation Flow limitation reached
Cooling mode off	Cooling mode deactivated

- **State heat pump (8006)**

End use (Info level)	Commissioning, Engineer
Emergency mode	Emergency mode
Fault	Fault
Locked	Locked, outdoor temperature Locked, external Locked, economy mode
Limitation time active	Consumer flow rate controller Minimum outdoor temperature use limitation Maximum outdoor temperature use limitation Maximum switch off temperature limitation Maximum OT limitation cooling Minimum switch off temperature limitation Compressor minimum switch off time active Excess heat compensation
Frost protection active	Heat pump frost protection
Defrosting activated	Defrosting activated
Cooling mode active	Compressor minimum on time active Compressor 1 on
Heating	Compressor minimum on time active Heat deficiency compensation Maximum condenser difference limitation Minimum condenser difference limitation Compressor 1 and heater on Compressor 1 on Heater on
Frost protection active	Installation frost protection active
Off	Flow active Switch-off delay active No demand
Switch-off delay active	No demand

- **State swimming pool (8011)**

End use (Info level)	Commissioning, Engineer
Manual action active	Manual action active
Fault	Fault
Heating mode restriction	Heating mode restriction
Forced draft	Forced draft
Heating	Generator heating mode
Heated, max pool temperature	Heated, max pool temperature
Heated	Heated, generator setpoint
Heating off	Solar heating mode off Generator heating mode off
Cooling	Cooling

- **State supplementary source (8022)**

End use (Info level)	Commissioning, Engineer
Locked	Locked, solid fuel boiler Locked, outside temperature Locked, economy mode
In operation for HC, DHW	In operation for HC, DHW
Released for HC, DHW	Released for HC, DHW
In operation for DHW	In operation for DHW
Released for DHW	Released for DHW
In operation for heating circuit	In operation for heating circuit
In operation for HC, DHW	In operation for HC, DHW
Released for HC, DHW	Released for HC, DHW
In operation for DHW	In operation for DHW
Released for DHW	Released for DHW
In operation for heating circuit	In operation for heating circuit
Released for HC	Released for HC
Overrun active	Overrun active
Off	Off

3-18. Diagnostics heat generation functions

Line	Access	Function	Setting range or display	Factory setting
8400	I	Compressor 1	Off, On	Off
8402	I	Electrical resistance flow 1	Off, On	Off
8403	I	Electrical resistance flow 2	Off, On	Off
8406	I	Condenser pump	Off, On	Off
8407	S	Speed condenser pump	0...100%	---
8410	U	Return temperature HP	0...140°C	---
		Setpoint (flow) HP	0...140°C	---
8412	U	Flow temperature HP	0...140°C	---
		Setpoint (flow) HP	0...140°C	---
8413	U	Compressor modulation	0...100%	---
8414	I	Modulation electric flow	0...100%	---
8425	S	Temperature differential condenser	-50...140°C	---
8450	S	Hours run compressor 1	00:00	---
8454	S	Locking time Heat Pump Reset? (no, yes)	0...2730 h	---
8455	S	Counter number of locks HP Reset? (no, yes)	0...65535	---
8456	S	Hours run electric flow Reset? (no, yes)	0...2730 h	---
8457	S	Start counter electric flow Reset? (no, yes)	0...65535	---
8458	I	State smart grid	Draw disabled Draw free Draw wish Draw forced	Draw free
8460	I	Heat pump throughput	0...65535 l/min	---

Various setpoints and actual values, relay switch status data can be displayed for purpose of diagnosis.

• Heat pump

Line	Function
8402	Electric immersion heater 1 flow
8403	Electric immersion heater 2 flow
8406	Condenser pump

These lines are used to check the operating mode of the components controlled by heat pump relays. The display "0" means that the associated components are currently disconnected. The display "1" means that the associated components are currently switched on.

NOTE: This information applies to relays defined as normally open contacts. For normally closed contacts, the action is reversed.

• Setpoints and measured values

Line	Function
8410	Return temperature HP
8412	Flow temperature HP
8413	Compressor modulation
8414	Modulation electric flow
8425	Temperature difference condenser

These lines allow the various setpoints and measured values for the heat pump to be viewed.

- **Hour/Start-up counter**

Line	Function
8450	Hours run compressor 1
8454	Locking time HP
8455	Counter number of locks HP
8456	Hours run electric flow
8457	Start counter electric flow

- **Hours run compressor 1:** This operating line shows the total number of hours run of compressor 1 since it was first commissioned.
- **Locking time HP:** Displays the cumulative locking time since start-up by the electrical services (via external locking signal).
- **Counter number of locks HP:** Displays the cumulative locks since start-up by the electrical services (via external locking signal).
- **Hours run electric flow and Start counter electric flow:** These lines are used to view the hours of operation and the number of start-up of electric heater.

3-19. Diagnostics consumers functions

Line	Access	Function	Setting range or display	Factory setting
8700	U	Outside temperature	-50...50°C	---
8701	U	Outside temperature minimum Reset? (no, yes)	-50...50°C	50°C
8702	U	Outside temperature maximum Reset? (no, yes)	-50...50°C	-50°C
8703	I	Outside temperature attenuated Reset? (no, yes)	-50...50°C	---
	This is the average of the outside temperature over a 24-hour period. This value is used for automatic Summer/Winter switchover (line 730).			
8704	I	Outside temperature composite	-50...50°C	---
	The mixed outside temperature is a combination of the current outside temperature and the average outside temperature calculated by the regulator. This value is used for calculating the initial temperature.			
8730	I	Heating circuit pump, circuit 1	Off, On	Off
8731	I	Mixer valve HC1 open	Off, On	Off
8732	I	Mixer valve HC1 closed	Off, On	Off
8740	U	Room temperature 1	0...50 °C	---
		Room setting 1		20°C
8743	U	Flow temperature 1	0...140 °C	---
		Flow temperature setpoint 1		---
8749	I	Room thermostat 1	No demand, Demand	No demand
8756	U	Cooling flow temperature 1	0...140 °C	---
		Cooling flow temperature setpoint 1		---
8820	I	DHW pump	Off, On	Off
8821	I	Electric immersion heater DHW	Off, On	Off
8830	U	DHW temperature	0...140 °C	---
		DHW temperature setpoint		50°C
8832	I	DHW temperature 2	0...140 °C	---
8840	S	Hours run DHW pump	0...2730h	---
8841	S	Start counter DHW pump	0...199999	---
8842	S	Hours run electric DHW	0...2730 h	---
8843	S	Start counter electric DHW	0...65535	---
8950	I	Common flow temperature	0...140°C	---
		Common flow temperature setpoint		---
8957	I	Common flow setpoint refrigerant	0...140°C	---
9005	I	Water pressure 1	-100...500 bar	---
9006	I	Water pressure 2	-100...500 bar	---
9009	I	Water pressure 3	-100...500 bar	---
9010	I	Measurement room temperature 1	0...50 °C	---
9011	I	Measurement room temperature 2	0...50 °C	---
9031	I	Relay output QX1	Off, On	On
9032	I	Relay output QX2	Off, On	On
9033	I	Relay output QX3	Off, On	On
9034	I	Relay output QX4	Off, On	Off
9035	I	Relay output QX5	Off, On	Off

Various setpoints and actual values, relay switch status and timing data can be displayed for purpose of diagnosis.

- **Outside temperatures**

Line	Function
8700	Outside temperature
8701	Outside temperature minimum
8702	Outside temperature maximum
8703	Outside temperature attenuated
8704	Outside temperature composite

The current, minimum, maximum, attenuated, and averaged temperatures are displayed.

- **Heating circuits**

Line	Function
8730 and 8760	Heating circuit pump 1 and 2
8731 and 8761	Heating circuit mix valve 1 open
8732 and 8762	Heating circuit mix valve 1 close
8740 and 8770	Room temperature 1 and 2
8743 and 8773	Flow temperature 1 and 2

The display “Off” means that the associated components are currently disconnected. The display “On” means that the associated components are currently switched on.

- **Cooling circuit**

Line	Function
8756	Flow temperature cooling 1
8757	Flow temperature setpoint cooling 1

The actual value of the cooling mode are displayed. The cooling mode room setpoint is displayed on line 8741.

- **Domestic Hot Water (DHW)**

Line	Function
8820	DHW pump
8821	Electric immersion heater DHW
8830	DHW temperature
8840	Hours run DHW pump
8841	Start counter DHW pump
8842	Hours run electric DHW
8843	Start counter electric DHW

The measured values, the DHW circulation pump and charging temperature, operating hour, and start-up counters are displayed, as well as temperatures of the primary controllers and DHW heater.

- **Swimming pool**

Line	Function
8900	Swimming pool

The current temperature of the swimming pool is displayed.

- **Line**

Line	Function
8950	Common flow temperature

- **Multifunction relay status**

Line	Function
9031	Relay output QX1
9032	Relay output QX2
9033	Relay output QX3
9034	Relay output QX4
9035	Relay output QX5

The switching status of multifunction relays 1 to 5 can be viewed individually on these lines. The display “Off” means that the components assigned to this output are currently disconnected. The display “On” means that the associated components are currently switched on.

- **Status of relays for extension modules 1 and 2**

Line	Function
9050	Relay output QX21 module 1
9051	Relay output QX22 module 1
9052	Relay output QX23 module 1
9053	Relay output QX21 module 2
9054	Relay output QX22 module 2
9055	Relay output QX23 module 2

The switching status of the relays connected to extension modules 1 and 2 can be viewed on these lines. The display “Off” means that the components assigned to this output are currently disconnected. The display “On” means that the associated components are currently switched on.

- **I/O module**

Line	Function
9071	Relay output QX31
9072	Relay output QX32
9073	Relay output QX33
9074	Relay output QX34
9075	Relay output QX35

The switching status of each relay on the I/O module can be queried via these operating lines. The display “Off” means that the components assigned to this output are currently disconnected. The display “On” means that the associated components are currently switched on.

4. Electrical connections

4-1. Overview of all the electrical connections

The wiring diagram for the hydraulic indoor unit is shown in detail on electrical wiring diagrams.

RELATED LINKS

["1. OUTDOOR UNIT"](#)

["2. HYDRAULIC INDOOR UNITS"](#)

■ Overall layout for a simple installation (1 heating circuit)

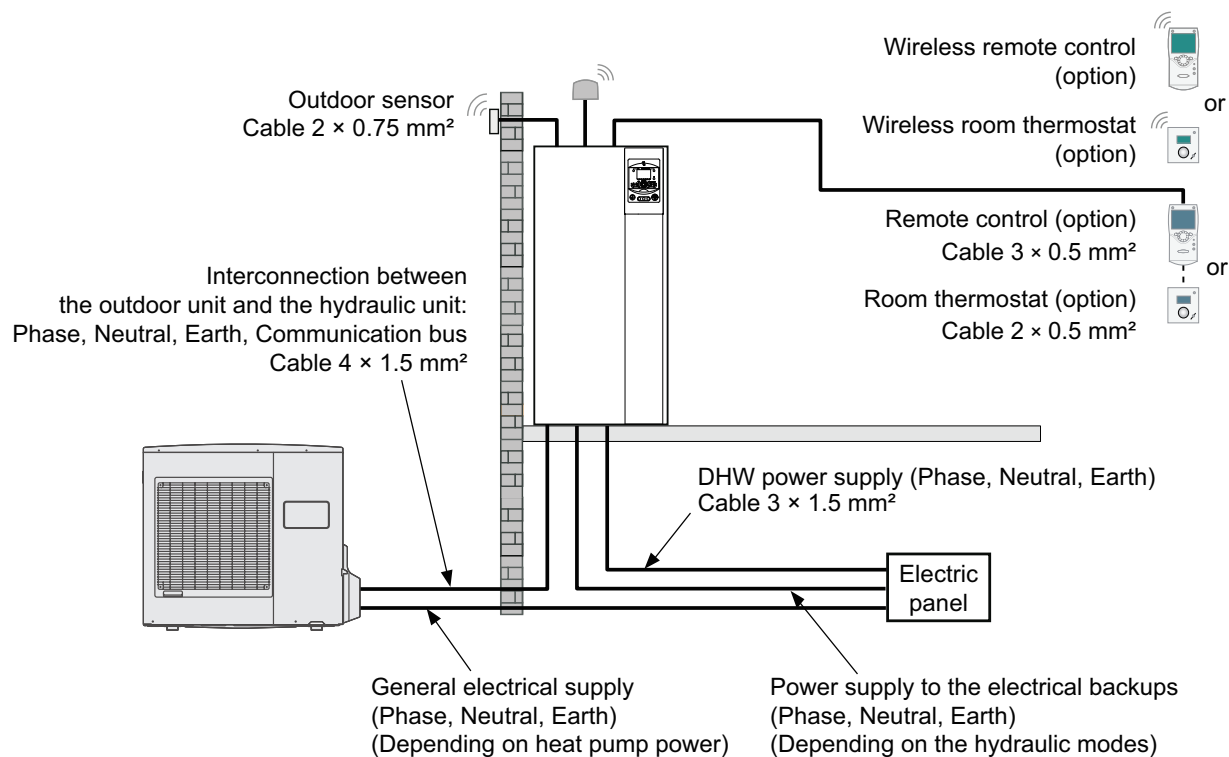

4-2. Electrical connections on the hydraulic indoor unit

⚠ CAUTION

Ensure that the general electrical power supply has been cut off before starting any repair work. The rearmament of safety thermostat should be done by a professional.

- Open the front cover.
- Open the power control box.
- Make the connections in accordance with the diagrams.
 - Single phase model

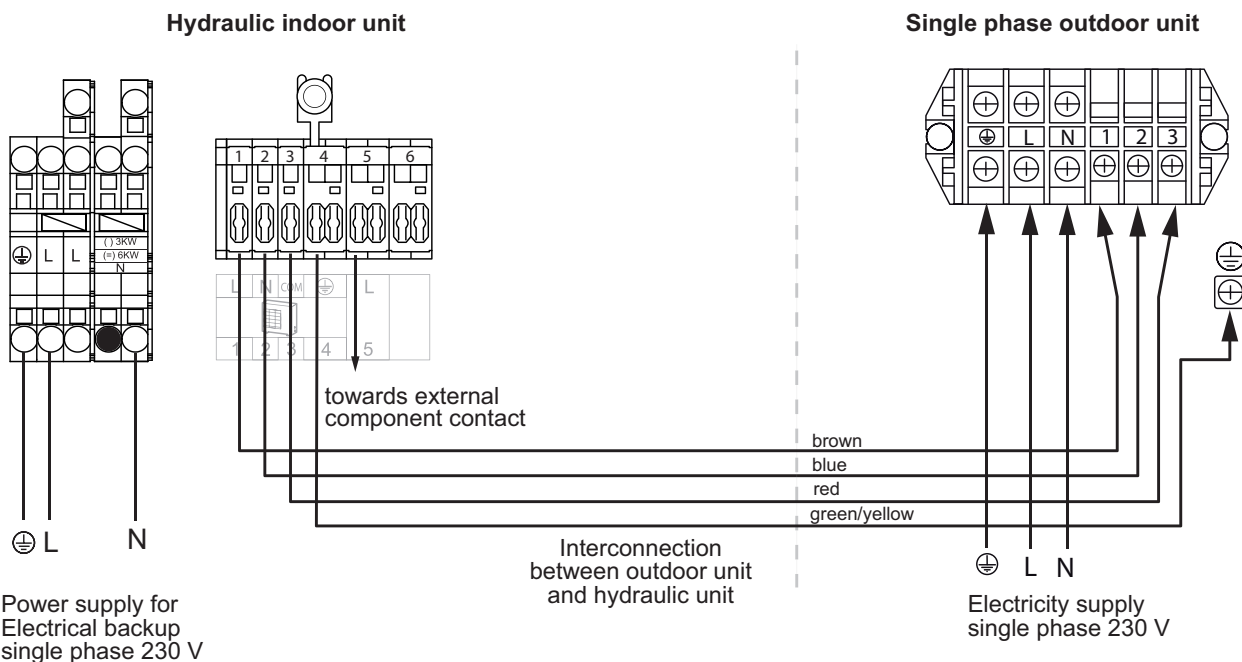

– 3-phase model

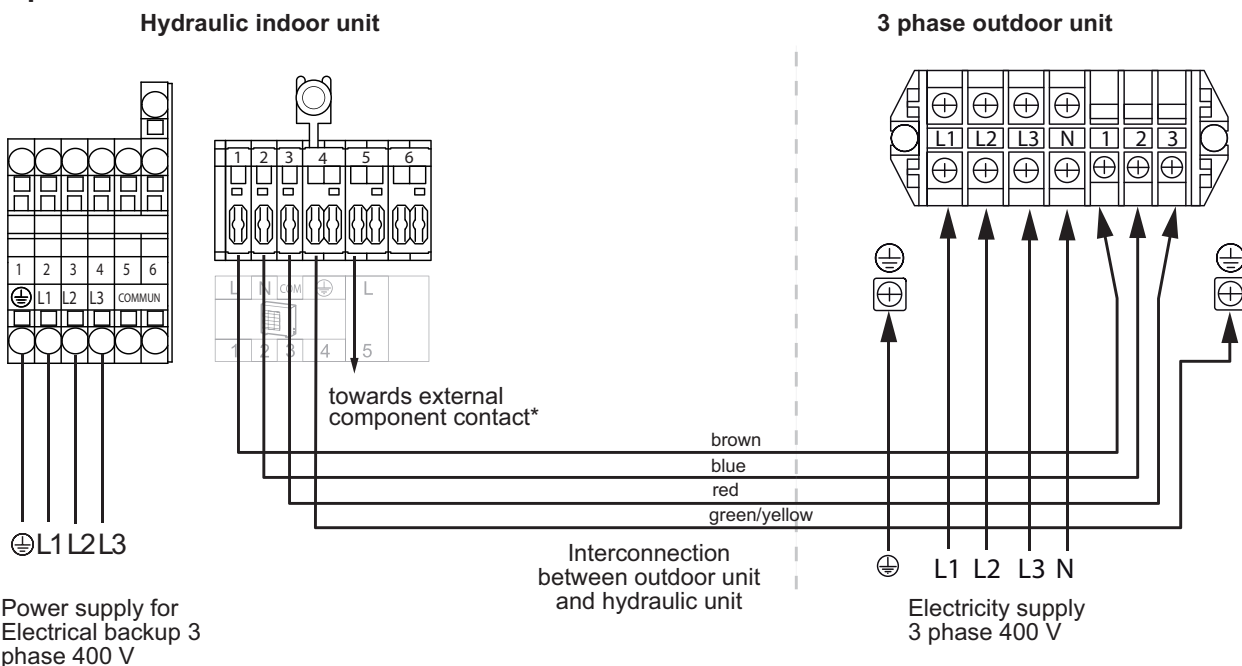

Cable passages

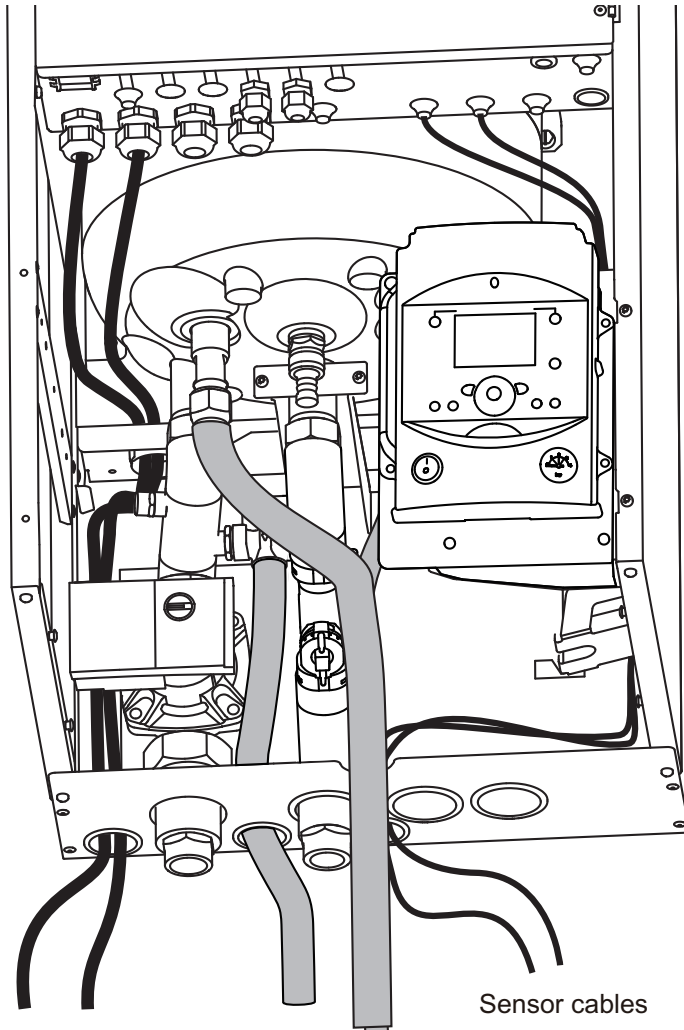

Power cables

Sensor cables

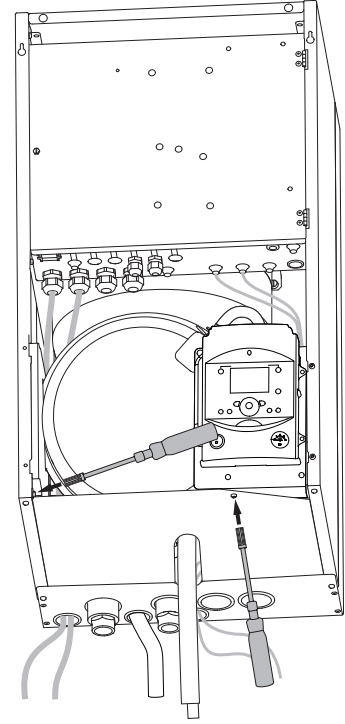

CONTROL SYSTEM

CONTROL SYSTEM

Do not place the sensor lines and sector supply lines in parallel to avoid causing inadvertent interference due to voltage points in the sector supply.

Ensure that all electrical cables are housed inside the spaces provided for this purpose.

– **Interconnection between the outdoor unit and the hydraulic indoor unit**

Comply with the correspondence between the markings on the hydraulic indoor unit's terminals and those on the outdoor unit when connecting the interconnection cables. A connection error could cause the destruction of one or other of the units.

– **Electric backups**

If the heat pump is not installed with a boiler connection, connect the electrical supply for the backups to the electrical panel.

– **Boiler connection**

Refer to the instructions supplied with the boiler connection kit and the boiler to be connected.

– **Second heating circuit**

Refer to the instructions supplied with the second circuit kit or/and regulation extension kit.

– **DHW tank with electrical backup heating**

Connect the electrical supply for the DHW tank to the electrical panel.

– **Contract with the power provider**

The heat pump's operation can be controlled to suit special contract (e.g. "Low-tariff", "Day/Night"). In particular, DHW at nominal temperature will be produced during the off-peak hours when electricity is cheaper.

- Connect the "Power Provider" contact to input EX2.
- Set the parameter line 1620 to "Low-tariff".
- 230 V on input EX2 = "Peak hours" information activated.

– **Power limitation or EJP (peak day removal)**

Power limitation is intended to reduce electrical consumption when this is too high compared to the contract with the power provider.

- Connect the "Power Provider" contact to input EX2.
- Set the parameter line 1620 to "Low-tariff".
- 230 V on input EX2 = "Peak hours" information activated.

– **External faults the heat pump**

Any component of carry-forward of information (thermostat, pressure switch, etc.) may signal an external problem and stop the heat pump.

- Connect the external component to input EX3.
- 230 V on input EX3 = Stoppage of heat pump (The system displays error 369.)
- In the case of a heated floor, connect the floor heating safety device into the connector of the floor heat pump (X12 or X110).

4-3. Connections to the heat pump regulator (Accessories and Options)

RELATED LINKS

"Wiring diagrams" in Chapter 2. HYDRAULIC INDOOR UNITS on page 02-5

■ Connection terminals

● Heat pump regulator RVS21.827

Low voltage		
Terminal		Use
X75	M	GND (common with interface PCB)
	DI7	HP error
	DI6	Defrost
	Uref	Compressor modulation
	UX3	
	D3	HP operation on/off
	DO2	HP operation mode (HEAT/COOL)
X80	BX1	Flow sensor
	M	Common
	BX2	Return sensor
X82	UX1	Not used
	M	
X84	BX3	DHW sensor
	M	
	BX4	Outdoor sensor
	M	
X86	1	Room thermostat or Remote control
	2	
	3	
	B1	Room thermostat
	M	
	B2	
X30		Not used
X50		User interface
X60		RF module
X70		LPB clip
X100		Regulation extension kit (UTW-KREXD)

NOTE: Colored items are for options.

Main voltage		
Terminal		Use
X10	L	Power supply
	Earth	
	N	
X11	EX1	Power shedding
	EX2	Peak time/off-peak times
	EX3	External fault
X12	QX1	Circulation pump*
	N	
X13	QX2	Backup HTR 1 or Distribution valve for boiler (Single phase model)
	$\overline{\text{QX2}}$ (inverted)	
	N	
X14	FX3	Backup HTR 2 or Boiler control (On/Off) (Single phase model)
	QX3	
X15	QX4	Distribution valve for DHW
	$\overline{\text{QX4}}$ (inverted)	
	N	
	QX5	Backup HTR for DHW
	N	

*: If the 2nd circuit kit are installed in the system, this circulation pump is assigned for higher temperature circuit.

● Regulation extension kit (UTW-KREXD)

Low voltage		
Terminal		Use
X150	1	Room thermostat or remote control for lower temperature circuit
	2	
	3	
	B1	
	M	
	B2	
X152	H33	External input*
	M	
X153	BX31	Flow sensor for lower temperature circuit
	M	
X154	BX32	Not used
	M	
	BX33	
	M	Swimming pool temperature sensor
	BX34	
	M	
X100		Heat pump regulator

*: Input H33 can be applied to one of several functions. (For details, refer to “Input H33 function”.)

Main voltage		
Terminal		Use
X10	L	Power supply
	Earth	
	N	
X110	QX31	Mixing valve for 2 nd circuit or Pilot wire
	QX32	
	N	Circulation pump for lower temperature circuit
	QX33	
X112	N	Not used
	QX34	
	QX35	Distribution valve for swimming pool
	$\overline{\text{QX35}}$ (inverted)	
	N	

■ Outdoor sensor

The outdoor sensor is required for the heat pump to operate correctly.

Consult the fitting instructions on the sensor's packaging. Place the sensor on the coldest part, generally the northern or north-eastern side.

In any case, it must not be exposed to morning sun. It must be installed so as to be easily accessible but at least 2.5 m from the floor. It is essential that it avoid any sources of heat such as flues, the upper parts of doors and windows, proximity to extraction vents, the underneath of balconies and under eave areas which would isolate the sensor from variations in the outdoor air temperature.

Connect the outdoor sensor to the M and BX4 (B9) terminals on the heat pump control board.

■ Room thermostat and/or remote control

The room thermostat (remote control) is optional.

Consult the fitting instructions on the sensor's packaging. The sensor must be installed in the living room area on a very uncluttered wall, 1.5 m above the floor.

Avoid direct sources of heat (chimney/flue, television, cooling hobs), draughty areas (ventilation, door, etc.). Air leaks in the seals in the constructions are often translated into cold air blowing through the electrical conduits. Lag the electrical conduits if there is a cold draught on the back of the IR sensor.

• Installing a room thermostat

– Room thermostat

Connect the room thermostat to the X86 connector of the heat pump's regulator board using the connector provided (terminal 1, 2).

– Room thermostat radio

Connect the wireless room thermostat radio to the connector X60.

• Installing a remote control

– Remote control unit

Connect the remote control unit to X86 connector of the heat pump's regulator board using the connector provided (terminal 1, 2, and 3).





– Remote control unit radio

Connect the wireless remote control unit radio to the connector X60.

■ Start-up

- Make sure that all DIP switches on the interface card are off before starting up. DIP switches should be set off for normal operation. Power supply to the hydraulic indoor unit must be turned off while touching DIP switches.
- Close the installation's main circuit breaker. On the first commissioning (or in winter), to allow the compressor to pre-heat, engage the installation's main circuit breaker (power supply to the outdoor unit) some hours before starting up the tests.
- Engage the start/stop switch. To ensure that inputs EX1, EX2, and EX3 operate correctly, check that the live-neutral polarity of the electrical supply is correct. When the power is switched on and every time that the ON/OFF button is switched off and then switched on again, the outdoor unit will take approximately 4 minutes to start up, even if the setting is requesting heating. The display can show error 370 when the appliance (re)starts. Do not be concerned, the communication between the outdoor unit and the hydraulic indoor unit will reestablish itself in a few months.

During the regulator initialization phase, the display shows all the symbols and then "Data update" and then "State heat pump".

- Make all the specific adjustments to the setting (configuring the installation).
- Press the key .
- Hold down the key  for 3 seconds and select the access level used with the aid of the knob .
- Confirm with the key .

Parameter the heat pump's setting (Refer to "Function table" on page 03-7).

On commissioning (or the case of error 10), the electrical backup heaters may start up even if the outdoor temperature at the time is above the heaters' trigger temperature.

The regulating system uses an average initial outdoor temperature of 0°C and requires some time to update this temperature.

NOTE: To avoid this situation, the sensor must be connected correctly.

Reinitialize line 8703 (commissioning level, consumer diagnosis menu)

■ Configuring the room thermostat

Configure the room thermostat and connect it to the appropriate heating zone:

- Hold down the presence key for more than 3 seconds.
The room thermostat displays RU and a number flashes.
- Turn the wheel to choose the zone (1, 2).
If the installation is fitted with 2 rooms thermostats:
 - The first connect one room thermostat and configure it in zone 2.
 - Then connect the other room thermostat and configure it as default in zone 1.
- Hold down the presence key; the room thermostat displays P1 and a flashing number.
 - Flashing number: 1
Automatic recording: a correction of the setting with the button is adopted without any particular confirmation (timeout) or by pressing the mode key.
 - Flashing number: 2
Recording with confirmation: a correction of the setting with the button is not adopted until the mode key is pressed.
- Press the presence key again; the room thermostat displays P2 and a flashing number.
 - Flashing number: 0
Off: all the operating elements are engaged.
 - Flashing number: 1
On: the following operating elements are locked.
 - Switching over the heating circuit's operating mode
 - Adjusting the comfort setpoint
 - Changing the operating level

The room thermostat displays off for 3 seconds when a locked button is pressed.

■ Configuring the remote control (Radio)

During commissioning, after an installation period of approximate 3 minutes, the user's language must be set:

- Press the key .
 - Choose menu "Operator section".
 - Choose "Language".
 - Select the language menu (**English**, Français, Nederlands, Español, etc.)
- In the case of 2 heat circuits;
- Choose the allocation of the remote control unit (room appliance 1 or 2...) line 40.
 - According to the allocation selected check and, if necessary, modify the settings for lines 42, 44, 48.

Line	Access	Function	Setting range or display	Factory setting
40	I	Use as...	Room appliance 1, 2, P User interface 1, 2, P Service appliance	Room appliance 1
			This line regulates the use of the room control unit. Depending on how it is used, other settings will be necessary (Lines 42, 44, 48).	
42	I	Appliance allocation 1	Heating circuit 1 Heating circuit 1 and 2 Heating circuit 1 and P All the heating circuits	Heating circuit 1
44	I	Operation HC2 (command HC2)	Commonly with HC1 Independent	Commonly with HC1
			This function enables you to choose whether you wish the room thermostat (as an option) to act both zones or just a single zone.	
48	I	Occupancy control switch function	Without Heating circuit 1 Heating circuit 2 Common	

NOTE: These parameter lines are accessible from the remote control unit.

5. Outdoor sensor

5-1. Model: QAC34

■ Dimension

Unit: mm

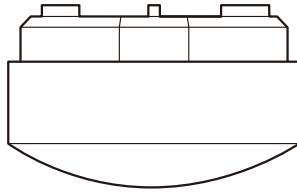

Top view

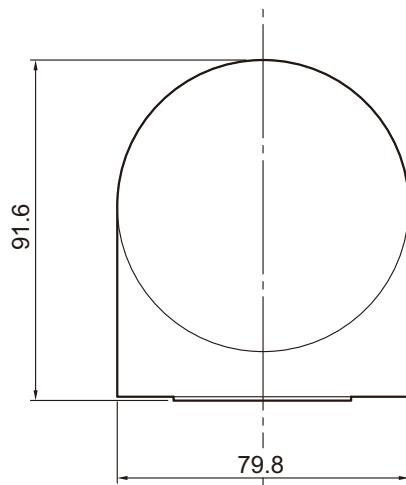

Front view

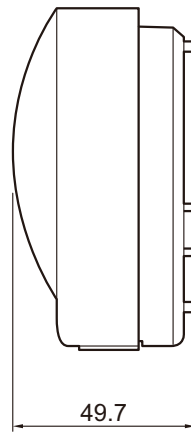

Side view

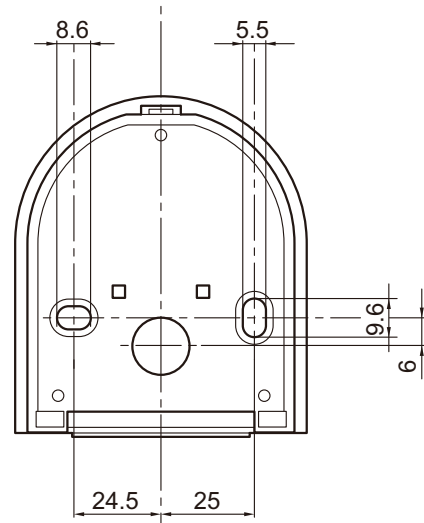

Rear view

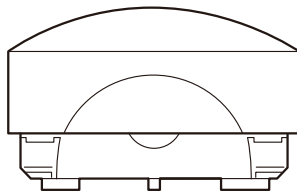

Bottom view

■ Installation

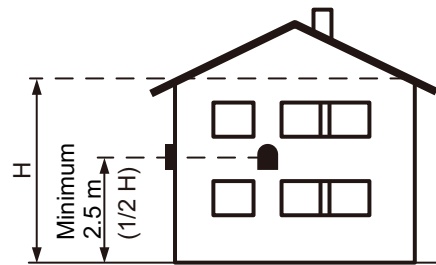
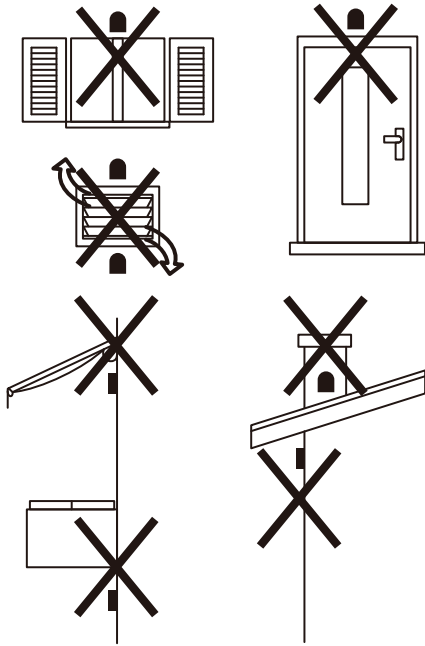
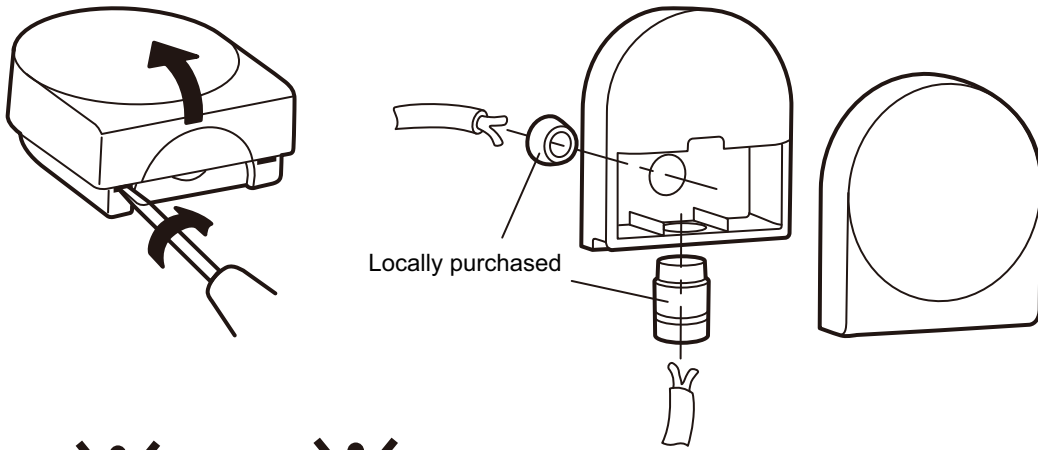

■ Wiring specifications

Use	Size	Wire type	Remarks
Outdoor sensor cable	0.75 mm ²	2 wires connection Maximum cable length: 60 m	Use shielded (Locally purchased) in accordance with the regional cable standard.

■ Specifications

Size (W × H × D)	mm	91.6 × 79.8 × 49.7
Weight	g	73
Cable length	m	60